

# Honeywell

THE POWER OF **CONNECTED**

# Honeywell BW™ Solo User Manual



# Honeywell BW Solo User Manual

## Product Registration

Register your product online by visiting:

By registering your product, you can:

- Receive notification of product upgrades or enhancements
- Be alerted to training classes in your area
- Take advantage of special offers and promotions

## IMPORTANT! BUMP TEST THE MONITOR BEFORE EACH DAY'S USE

Prior to each day's use, every gas detection monitor should be bump tested to confirm the response of all sensors and activation of all alarms by exposing the monitor to a concentration of target gas that exceeds the low alarm set point. A bump test is also recommended if the monitor has been subjected to physical impact, liquid immersion, an Over Limit alarm event, or custody changes, or anytime the monitor's performance is in doubt.

To ensure greatest accuracy and safety, only bump test and calibrate in a fresh air environment. The monitor should be calibrated every time it does not pass a bump test, but no less frequently than every six months, depending on use and exposure to gas and contamination, and its operational mode.

- Calibration intervals and bump test procedures may vary due to national legislation.
- Honeywell recommends using calibration gas cylinders containing the gas that is appropriate to the sensor you are using, and in the correct concentration.

© 2018 Honeywell International.

# Honeywell BW Solo User's Guide

## Contents

1. Standard Contents.....	9
2. General Information.....	9
3. User Interface & Display Overview.....	10
3.1. Out-Of-Box Experience (First Time Use Only).....	11
3.2. Status Indicator Icons.....	12
4. BLE (Bluetooth Low Energy) Operation.....	13
4.1. BLE Icons.....	13
4.2. Non-Compliance Indicator LEDs.....	13
4.3. Pairing With Smartphones.....	14
5. Battery.....	17
5.1. Battery Status.....	17
5.2. Battery Replacement.....	17
6. Turning The Honeywell BW Solo On & Off.....	19
6.1. Turning The Honeywell BW Solo On.....	19
6.2. Turning The Honeywell BW Solo Off.....	19
6.3. Calibration Status.....	19
6.4. Bump Status.....	20
6.5. Sensor Fault Status.....	20
7. Navigation.....	21
7.1. Glance Navigation.....	21
7.2. Main Navigation.....	22
8. Navigation: Information Menu.....	23
8.1. Event Log Navigation.....	24
9. Navigation: Settings.....	25
9.1. Enter Settings Mode.....	25
9.2. Menus & Submenus In Settings Mode.....	26
9.3. Language.....	27
9.4. Time.....	27
9.5. Date.....	27
9.6. Units.....	27
9.7. Readings.....	27
9.8. Setpoints.....	28
9.9. Latching.....	28
9.10. Reminders.....	28
9.10.1. Force On or Off for Bump/Cal.....	28
9.10.1.1. Force Cal.....	28
9.10.1.2. Force Bump.....	29
9.11. Data Logging.....	29
9.12. BLE.....	29
9.13. Assigned.....	29
9.14. Zone.....	29
9.15. IntelliFlash.....	30
9.16. Non-Compliance Indicator LEDs.....	31
9.17. Passcode.....	31
9.18. Exit.....	31

# Honeywell BW Solo User Manual

10. Zeroing .....	33
11. Bump Testing .....	33
12. Calibrating .....	35
13. Replacing The Filter & Sensor .....	36
13.1. Filter Color Reference .....	36
13.2. Removing The Cover .....	36
13.3. Replacing The Filter .....	37
13.4. Replacing The Sensor .....	37
13.4.1. 4-Series Sensor Replacement .....	38
13.4.2. 1-Series Sensor Replacement .....	40
13.5. Reinstalling The Cover .....	42
14. Maintenance .....	43
14.1. Cleaning .....	43
14.2. Replacing The Alligator Clip .....	43
14.3. Replacing/Serviceing Other Parts .....	43
15. Firmware Update .....	43
16. Year Of Manufacture .....	43
17. Sensors & Settings .....	44
18. Troubleshooting .....	46
19. Honeywell BW Solo Specifications .....	47
20. Limited Warranty and Limitation of Liability .....	49

# Honeywell BW Solo User Manual



This Manual must be carefully read by all individuals who have or will have the responsibility of using, maintaining, or servicing this product. The product will perform as designed only if it is used, maintained, and serviced in accordance with the manufacturer's instructions. The user should understand how to set the correct parameters and interpret the obtained results.

For safety reasons, this equipment must be operated and serviced by qualified personnel only. Read and understand the user manual completely before operating or servicing.

## AVERTISSEMENT

Pour des raisons de sécurité, cet équipement doit être utilisé, entretenu et réparé uniquement par un personnel qualifié. Étudier le manuel d'instructions en entier avant d'utiliser, d'entretenir ou de réparer l'équipement.

## Read Before Operating

This manual must be carefully read by all individuals who have or will have the responsibility of using, maintaining, or servicing this product. The product will perform as designed only if it is used, maintained, and serviced in accordance with the manufacturer's instructions. The user should understand how to set the correct parameters and interpret the obtained results.

## CAUTION!

To reduce the risk of electric shock, turn the power off before opening this instrument or performing service. Never operate the instrument when the instrument is open. Service this product only in an area known to be non-hazardous.

## Proper Product Disposal At End Of Life



### EU Directive 2012/19/EU: Waste Electrical and Electronic Equipment (WEEE)

This symbol indicates that the product must not be disposed of as general industrial or domestic waste. This product should be disposed of through suitable WEEE disposal facilities. For more information about disposal of this product, contact your local authority, distributor, or the manufacturer.

# Honeywell BW Solo User Manual

## CAUTION!

This product is a gas detector, not a measurement device.

- Ensure that the sensor cap is free of dirt, debris, and is not obstructed.
- Clean the exterior with a soft, damp cloth.
- For optimal performance, periodically zero the sensor in a normal atmosphere (20.9% v/v O<sub>2</sub>) that is free of hazardous gas.
- Portable safety gas detectors are life safety devices. Accuracy of ambient gas reading(s) is dependent upon factors such as accuracy of the calibration gas standard used for calibration and frequency of calibration. Honeywell Analytics recommends performing a calibration at least once every 180 days (6 months).
- Any rapid up-scaling reading followed by a declining or erratic reading may indicate a gas concentration beyond the upper scale limit, which can be hazardous.
- Products may contain materials that are regulated for transportation under domestic and international dangerous goods regulations.
- Return product in compliance with appropriate dangerous goods regulations. Contact freight carrier for further instructions.
- Recycling: this instrument contains a lithium battery. Do not mix with the solid waste stream. Spent batteries should be disposed of by a qualified recycler or hazardous materials handler.

## Wireless Security Warning

Wireless data transmission can extend beyond your walls and can be received by anyone with a compatible adapter. Without proper protection, data can be compromised. Use the security features of all wireless equipment in your network.

- Bluetooth communication should always be set to OFF unless the functionality is required.
- If possible, pair devices ONLY when in a physically secure area.

# Honeywell BW Solo User Manual

## Caution

This device complies with Part 15 of the FCC Rules / Industry Canada license-exempt RSS standard(s). Operation is subject to the following two conditions: (1) this device may not cause harmful interference, and (2) this device must accept any interference received, including interference that may cause undesired operation.

Le présent appareil est conforme aux CNR d'Industrie Canada applicables aux appareils radio exempts de licence. L'exploitation est autorisée aux deux conditions suivantes : (1) l'appareil ne doit pas produire de brouillage, et (2) l'utilisateur de l'appareil doit accepter tout brouillage radioélectrique subi, même si le brouillage est susceptible d'en compromettre le fonctionnement.

Changes or modifications not expressly approved by the party responsible for compliance could void the user's authority to operate the equipment.

This equipment has been tested and found to comply with the limits for a Class B digital device, pursuant to part 15 of the FCC Rules. These limits are designed to provide reasonable protection against harmful interference in a residential installation. This equipment generates uses and can radiate radio frequency energy and, if not installed and used in accordance with the instructions, may cause harmful interference to radio communications. However, there is no guarantee that interference will not occur in a particular installation. If this equipment does cause harmful interference to radio or television reception, which can be determined by turning the equipment off and on, the user is encouraged to try to correct the interference by one or more of the following measures:

- Reorient or relocate the receiving antenna.
- Increase the separation between the equipment and receiver.
- Connect the equipment into an outlet on a circuit different from that to which the receiver is connected.
- Consult the dealer or an experienced radio/TV technician for help.

Under Industry Canada regulations, this radio transmitter may only operate using an antenna of a type and maximum (or lesser) gain approved for the transmitter by Industry Canada. To reduce potential radio interference to other users, the antenna type and its gain should be so chosen that the equivalent isotropically radiated power (e.i.r.p.) is not more than that necessary for successful communication.

Conformément à la réglementation d'Industrie Canada, le présent émetteur radio peut fonctionner avec une antenne d'un type et d'un gain maximal (ou inférieur) approuvé pour l'émetteur par Industrie Canada. Dans le but de réduire les risques de brouillage radioélectrique à l'intention des autres utilisateurs, il faut choisir le type d'antenne et son gain de sorte que la puissance isotrope rayonnée équivalente (p.i.r.e.) ne dépasse pas l'intensité nécessaire à l'établissement d'une communication satisfaisante.

# Honeywell BW Solo User's Guide

## Operation Area and Conditions

### Safety Certifications



Class I, Division 1, Groups A,B,C,D T4; Class I, Zone 0, AEx/Ex ia IIC T4 Ga  
-40°C ≤ Tamb ≤ 60°C

**ATEX:**

Sira 18ATEX2243,  
Tamb -40°C to 60°C



II 1G I M1 / Ex ia IIC T4 Ga / Ex ia I Ma

**IECEX:**

IECEX SIR 18.0058, Ex ia IIC T4 Ga / Ex ia I Ma Tamb = -40°C to +60°C

## INSTRUCTIONS FOR SAFE USE

**WARNING:** Read and understand instruction manual before operation or servicing.

**AVERTISSEMENT:** Lisez et comprenez le manual d'instructions avant d'utiliser ou d'effectuer l'entretien.

**WARNING:** Substitution of components may impact safety.

**AVERTISSEMENT:** La substitution de composants peut compromettre la sécurité.

**WARNING:** Lithium battery: Only use approved battery: 2/3AA 3.6V 1.65Ah Lithium battery (P/N: BWS-BAT01).

**AVERTISSEMENT:** Batterie Lithium: Utilisez uniquement des batteries approuvées: 2/3AA 3.6V 1.65Ah Batterie Lithium (N/P: BWS-BAT01).



# Honeywell BW Solo User Manual

## 1. Standard Contents

Standard Package includes:

- Detector complete with specified sensor, stainless-steel alligator clip and concussion-proof housing
- Test Cap with 1 ft of hose
- Quick Reference Guide

## 2. General Information

Honeywell BW Solo is easy to operate — even if you're wearing gloves. Using this button or the Honeywell SafetySuite Device Configurator software, you can easily configure set points, latching alarms, and other parameters. You can also access measurements for short-term exposure limit (STEL) and time-weighted average (TWA), and pair the wireless Honeywell BW Solo with our mobile apps:

- With the Device Configurator app, you can set up the detector, choose alarm set points and more — all from up to 6 meters away. Also use the app to see calibration readings, email calibration certificates and upgrade firmware.
- With the Safety Communicator app, detector readings are sent instantly to Honeywell's real-time monitoring software. Access it from any device with an internet connection, and get remote visibility on worker safety and location.

You can also use the wireless Honeywell BW Solo to share gas data with the desktop software — no dock required.

### Key Features

- Simple one-button operation
- Easy sensor, filter, and battery replacement
- Compatible with IntelliDoX for centralized data with automated bump testing, calibration, and instrument management.
- Option to activate IntelliFlash™ or non-compliance flash
- Ability to assign detectors to workers and locations
- Easy-to-read display for multiple languages
- Data logging with rolling 24-hour peak reading

# Honeywell BW Solo User Manual

## 3. User Interface & Display Overview

The BW Solo has a single button for on/off, parameter viewing, and programming functions. The display is backlit when you press the button.

*Front*

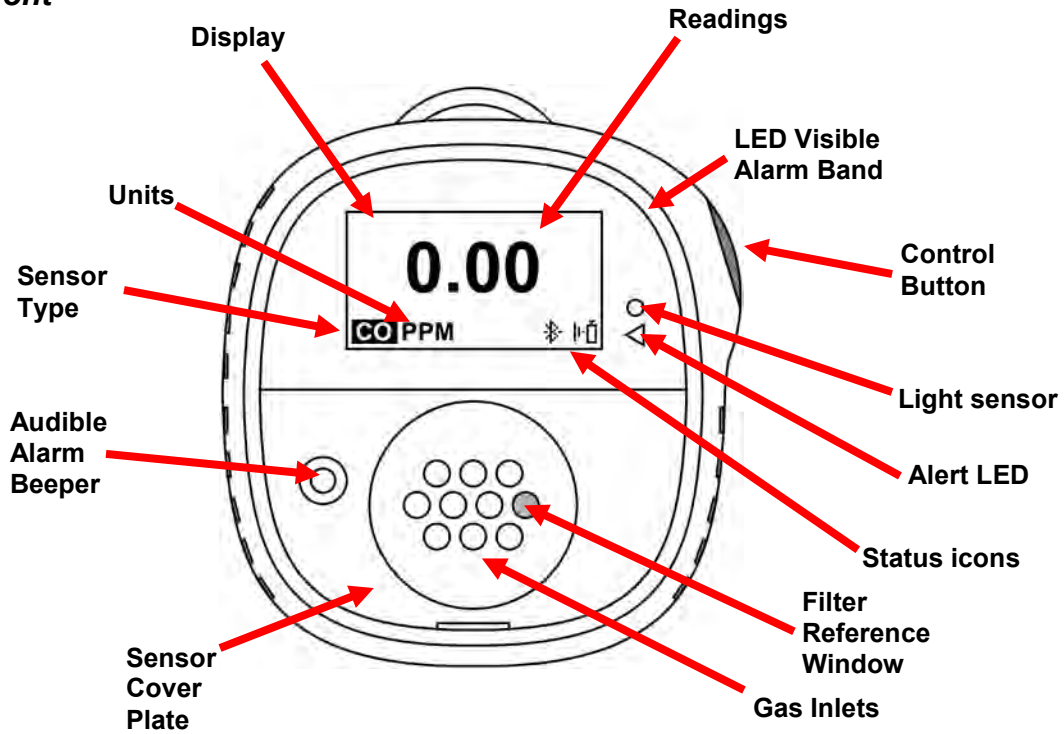

*Back*

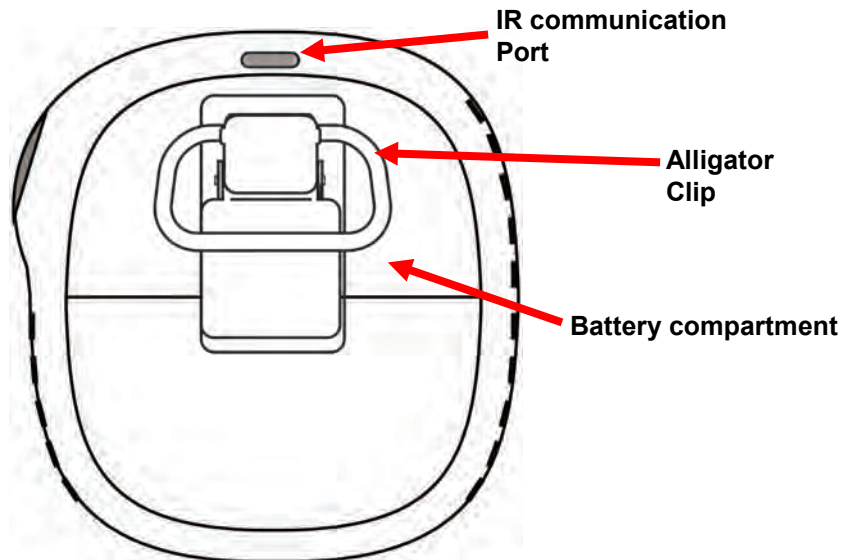

# Honeywell BW Solo User Manual

## 3.1. Out-Of-Box Experience (First Time Use Only)

The first time the instrument is turned on, you are prompted to select a display language and to enter time and date.

**Note:** Language selection during the first power-on is mandatory.

**Note:** If you do not press a button for 6 seconds during out-of-the-box power-on, the instrument automatically turns off. Language selection during the first power-on is mandatory, although you can skip the time and date. If a language was selected before this 6-second idle period, the instrument shows the normal reading screen after the next start-up. If a language has not been selected, then the next time the instrument is turned on, there is a prompt to select a language.

Press and hold the button for 3 seconds. When you power the unit on, it counts down, 3-2-1. LEDs flash, the vibration alarm shakes, and the audible alarm sounds, and the Honeywell logo then appears on the screen. After startup, the “Set language” screen is shown.

Step through the available languages by pressing the button. Once you see the language you want, press and hold the button for 1 second.

**Note:** If you pass the language you want, press the button until your language is shown. Then press and hold the button for 1 second.

Once you have set the language, wait 3 seconds, and the “Set time” screen is shown.

Press and hold the button for 1 second to set the time. Otherwise, press it once to change to “No.” Then press the button for 1 second to advance to “Set date.” If you change your mind and want to set the time, press the button once instead.

Set the hour (00 to 23) by pressing the button until you reach the correct hour. Once the hour is selected, press and hold the button for 1 second.

When “Set minute” is shown, press the button repeatedly to reach the correct minute (00 through 59). Then press and hold the button for 1 second. The time is now set.





### IMPORTANT!

If a major error that prevents the instrument from functioning is found during startup, an error number is shown on the display. Shut off the instrument and restart it. If the error message is shown again, shut off the instrument and contact Technical Services.

# Honeywell BW Solo User Manual

## 3.2. Status Indicator Icons

On-screen icons are used to indicate battery, bump, calibration and sensor status, as well as peak reading. The table below details how and when each icon is displayed. The triangular red LED located to the right of the screen illuminates to accompany these (it is active when the non-compliance feature is on).

Icon	Explanation
	<p>The battery icon is not shown on the display unless the remaining power is one day or less.</p> <ul style="list-style-type: none"> <li>• When the battery's remaining life falls below 24 hours, the battery icon is shown and there is a flash and beep every 60 minutes.</li> <li>• When the battery's remaining life falls below 8 hours, the icon blinks on and off every second, and there are two beeps and a flash every 30 seconds.</li> </ul>
	<p>When less than 12 hours remains before a bump test should be performed, this icon is shown and the buzzer sounds once every hour. When the user has also set the non-compliance option for the bump test reminder, the instrument beeps once every 10/30/60 seconds (the interval is set by the user).</p> <p>The icon blinks once per second if there is a failed or skipped bump test, and the instrument beeps three times every 60 minutes.</p> <p>A bump test is required (and indicated by this icon) if:</p> <ul style="list-style-type: none"> <li>• The defined period between bump tests has been exceeded (bump test overdue).</li> <li>• The sensor has failed a previous bump test.</li> </ul> <p>Failed bump test notification is shown on the screen if a bump test is failed. In the information menu, it shows that the bump test must be performed "NOW."</p> <p><b>Note:</b> the sensor should be challenged on a regular basis (before each day's use) to ensure proper sensor performance.</p>
	<p>This icon is shown when there is less than 12 hours remaining before a calibration should be performed. The instrument beeps once every 60 minutes.</p> <p>The icon blinks once per second if there is a failed or skipped calibration, and the instrument beeps three times every hour if the non-compliance option is on. When the user has also set the non-compliance option for the calibration reminder, the instrument beeps once every 10/30/60 seconds (the interval is set by the user).</p> <p>Calibration is required (and indicated by this icon) if:</p> <ul style="list-style-type: none"> <li>• The defined period between calibrations has been exceeded.</li> <li>• The sensor has failed a previous calibration.</li> </ul>
	<p>When a sensor fails, has been removed, or has expired, this icon is shown on the display, and there are is one beep per second. Stepping through the status screens, you see the fault details.</p>
	<p>The Peak Reading icon is displayed when a peak gas reading has been detected in the past 24 hours. The icon is otherwise hidden.</p>

# Honeywell BW Solo User Manual

## 4. BLE (Bluetooth Low Energy) Operation



Honeywell BW Solo is designed to operate via BLE (Bluetooth Low Energy) to send data to a smartphone running Safety Communicator. The data can then be sent to computers running Honeywell real-time monitoring software.

**Note:** If BLE operation is desired, the wireless option must be specified at time of ordering.

You can download Safety Communicator from the Google Play and iTunes store for free on one of the supported phone platforms. However, you need a Honeywell real-time monitoring software license to transmit monitor alarm information from Honeywell Real-Time Monitoring software.

### 4.1. BLE Icons

An icon is shown on the Honeywell BW Solo's screen to show the status of BLE (Bluetooth Low Energy), including connectivity.

Icon	Explanation
	BLE connected. The icon is shown when data is being transferred.
	BLE is off.
	BLE is on, but is not connected.

### 4.2. Non-Compliance Indicator LEDs

The non-compliance indicator LEDs flash in the following situations:

- Low battery
- Low, High, TWA, STEL, or Negative alarm
- Failed self-diagnostic test
- Failed bump test or calibration
- Overdue bump test or calibration

When a functional error occurs, the gas detector tries to recover from it. If an error persists, contact Honeywell Analytics or your distributor for technical assistance.

# Honeywell BW Solo User Manual

## 4.3. Pairing With Smartphones

**Note:** Bluetooth communication must be turned on in the Honeywell BW Solo instrument before attempting to pair it with smartphones or other iOS or Android devices.

1. Open the Safety Communicator program.



2. The app opens and begins scanning for nearby Bluetooth instruments. As instruments are found, they show up in the list. If the Honeywell BW Solo does not show up, click “Scan” so that it searches for the instrument.



# Honeywell BW Solo User Manual

When the Honeywell BW Solo is found, it shows up in the list, represented by its image and serial number:

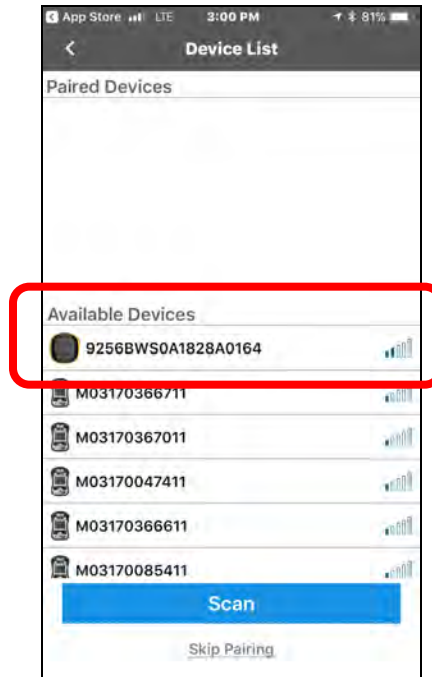

3. Click on the Honeywell BW Solo device that displays the serial number of the unit you are trying to connect. This message appears:

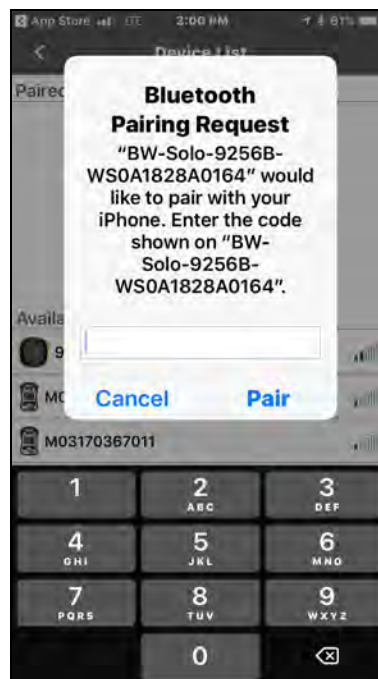

4. Look at the Honeywell BW Solo's screen, and you will see a code number. Input that code number into the field on your smartphone and then click "Pair."

# Honeywell BW Solo User Manual

If it pairs successfully, a confirmation message is shown:

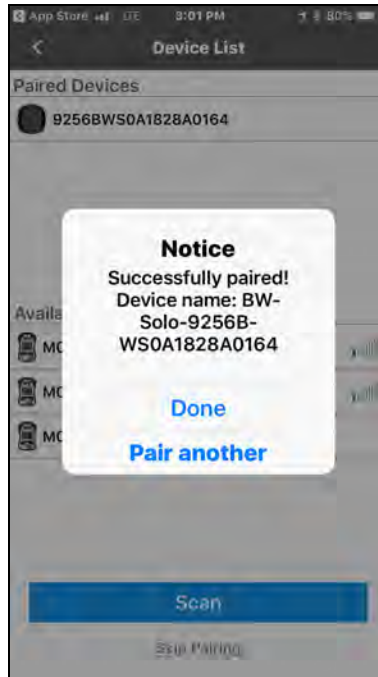

If you want to pair another instrument, click “Pair another.” Otherwise, click “Done.”

The Honeywell BW Solo is now sending data to Safety Communicator.





# Honeywell BW Solo User Manual

For further instructions, consult the Safety Communicator app. If you plan to use Honeywell real-time monitoring software, consult the relevant User Manual.

## 5. Battery

Always make sure the battery has enough power before using it. Only use this battery: 2/3AA 3.6V 1.65Ah Lithium battery (P/N: BWS-BAT01).

### 5.1. Battery Status

The battery icon is not shown on the display unless the remaining power is one day or less.



- When the battery's remaining life falls below 24 hours, the battery icon is shown, and there is a flash and beep every 60 minutes.
- When the battery's remaining life falls below 8 hours, the icon blinks on and off every second, and there are two beeps and a flash every 30 seconds.

**Note:** To preserve the life of the battery, deactivate the instrument when it is not in use.

### 5.2. Battery Replacement

#### WARNING

To reduce the risk of ignition of hazardous atmospheres, remove or replace the battery only in an area known to be non-hazardous!

#### CAUTION!

- Replace the battery in a safe area, free of hazardous gas, immediately when the detector enters low battery alarm.
  - Only use this battery: 2/3AA 3.6V 1.65Ah Lithium battery (P/N: BWS-BAT-01).
  - Wear an ESD wrist or heel strap when replacing the battery. Avoid touching electronic components or shorting circuits on the printed circuit board.
1. Flip up the alligator clip.
  2. Remove the Phillips screw and lock washer.
  3. Use the alligator clip to lift off the battery door.

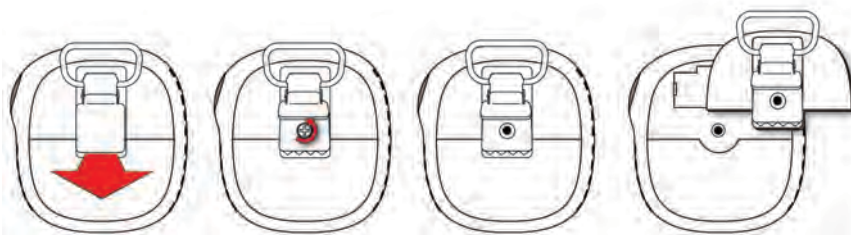

# Honeywell BW Solo User Manual

4. Turn over the battery door, remove the old battery, and then press the new battery into place. Note the polarity (+/- orientation).

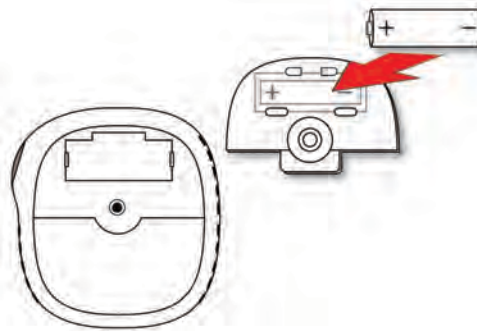

5. Turn over the battery door and align the battery over its compartment. Then press it into the instrument. Insert the screw and lock washer.

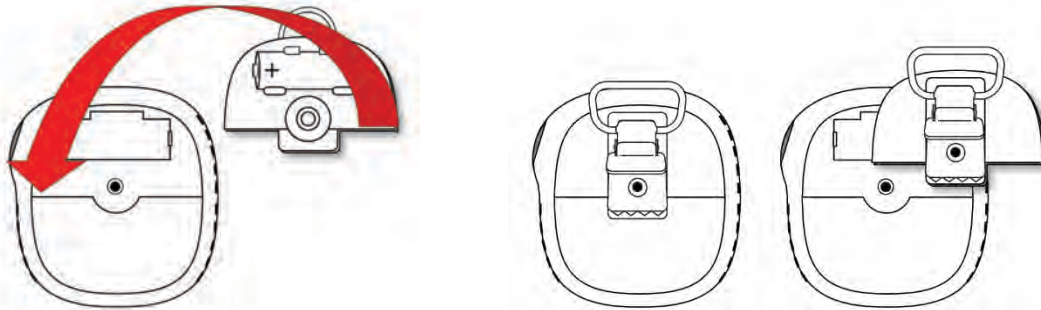

6. Tighten the screw. Do not overtighten the screw.



7. Turn on the instrument to make sure the battery was properly installed.

After a battery is inserted, the screen shows a blinking battery icon. The battery is being conditioned (depassivation), and it typically takes about 30 seconds. If more time is required, the blinking battery icon continues to be shown. When depassivation is complete, there is no battery icon on the screen. The instrument can now be turned on.



## IMPORTANT!

Used batteries must not be disposed of as general industrial or domestic waste. They should be disposed of through suitable disposal facilities.

# Honeywell BW Solo User Manual

## 6. Turning The Honeywell BW Solo On & Off

### 6.1. Turning The Honeywell BW Solo On

With the instrument turned off, press and hold the button for 3 seconds. There is a 3-2-1 countdown, and then the audible alarm sounds and the display and LED alarm lights turn on and off, plus the vibration alarm buzzes.

A Honeywell logo appears first, followed by a progress bar, and then the main reading display.

**Note:** The instrument checks for a critical low battery and will shut down if it is too low. It also checks for forced bump or forced calibration if the function is enabled and if bump or calibration is due.

### 6.2. Turning The Honeywell BW Solo Off

**Note:** You can only turn off the instrument from the main display screen.

Press and hold the button through the countdown. The unit will beep as the countdown progresses. Then the message "Powering Down" is shown. Release the button. When the instrument is off, the screen is dark.

### 6.3. Calibration Status

**Note:** When forced bump and calibration are enabled, the instrument will power down if it is not bump tested or calibrated.



This icon is shown when less than 12 hours remains before a calibration should be performed. The instrument beeps once every 10/30/60 seconds, as set by the user, when the user has also set the non-compliance option for the calibration reminder.

The icon blinks twice per second if there is a failed or skipped calibration, and the instrument beeps three times every 60 seconds.

A calibration is required (and indicated by this icon) if:

- The defined period between calibrations has been exceeded (calibration overdue).
- The sensor has failed a previous calibration.

Failed calibration notification is shown on the screen if a calibration is failed. In the information menu, it shows that the calibration must be performed "NOW."

**Note:** The sensor should be challenged on a regular basis (before each day's use) to ensure proper sensor performance.

# Honeywell BW Solo User Manual

## 6.4. Bump Status

**Note:** When forced bump and calibration are enabled, the instrument will power down if it is not bump tested or calibrated.



This icon is shown when less than 12 hours remains before a bump test should be performed. The instrument beeps once every 10/30/60 seconds, as set by the user, when the user has also set the non-compliance option for the bump test reminder.

The icon blinks twice per second if there is a failed or skipped bump test, and the instrument beeps three times every 60 seconds.

A bump test is required (and indicated by this icon) if:

- The defined period between bump tests has been exceeded (calibration overdue).
- The sensor has failed a previous bump test.

Failed bump test notification is shown on the screen if a bump test is failed. In the information menu, it shows that the calibration must be performed "NOW."

**Note:** the sensor should be challenged on a regular basis (before each day's use) to ensure proper sensor performance.

## 6.5. Sensor Fault Status

When a sensor has been removed or failed, this icon is shown on the display, and there is one flash, one beep, and a vibration alert every second. Stepping through the status screens, you see the fault details.



# Honeywell BW Solo User Manual

## 7. Navigation

All navigation is done by pressing the single button on the Honeywell BW Solo. Here are the basic “rules” of navigation on the instrument:

<b>Power On</b>	3-second hold
<b>Power Off</b>	5-second hold from the main screen
<b>Enter menus (from main screen)</b>	Double-click
<b>Move to next choice</b>	Single-click (quickly press once)
<b>Select current choice</b>	Short Hold (press and hold for 1 second)
<b>Hold until acknowledged</b>	Cursor or current choice stops blinking Cursor moves to next choice
<b>Hold through countdown</b>	Long Hold (press and hold for 3 seconds) Selected process is initiated

### 7.1. Glance Navigation

At the main screen, press the button once, and the backlight comes on. In addition, a critically low battery level and any compliance issues are shown. For example, if the instrument fails a bump test, it will show a Bump FAIL. If there is a failure, an associated icon and fault message alert you.

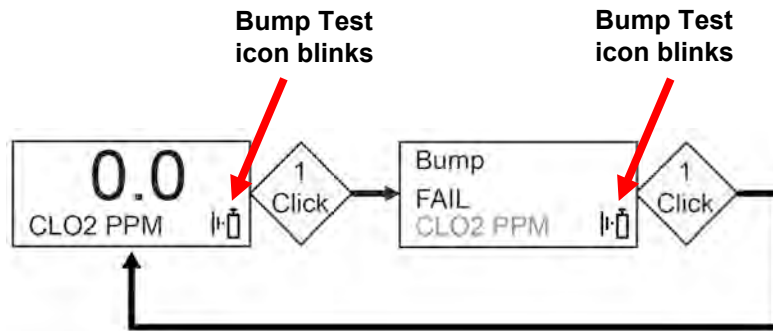

In addition, if there is a failure or low battery, the Alert LED will illuminate.

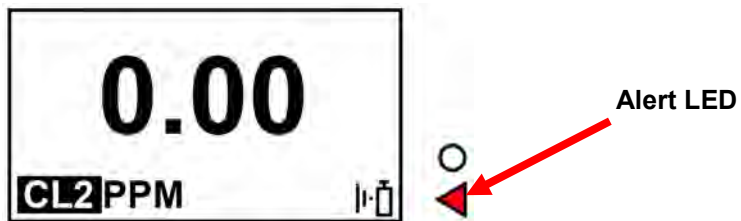

**Note:** When the last screen is reached, if you click the button once, it returns to the main screen. If you do not click the button for 6 seconds from any of the screens, it returns to the main screen automatically.

# Honeywell BW Solo User Manual

## 7.2. Main Navigation

1. Start at the main screen and click the button twice in rapid succession (similar to a double mouse-click) to start.
2. The first option you see is ">Information". Step through the other top-level options one click at a time.

**Note:** A cursor (>) before a heading indicates that there are submenus or editable parameters below the current screen.

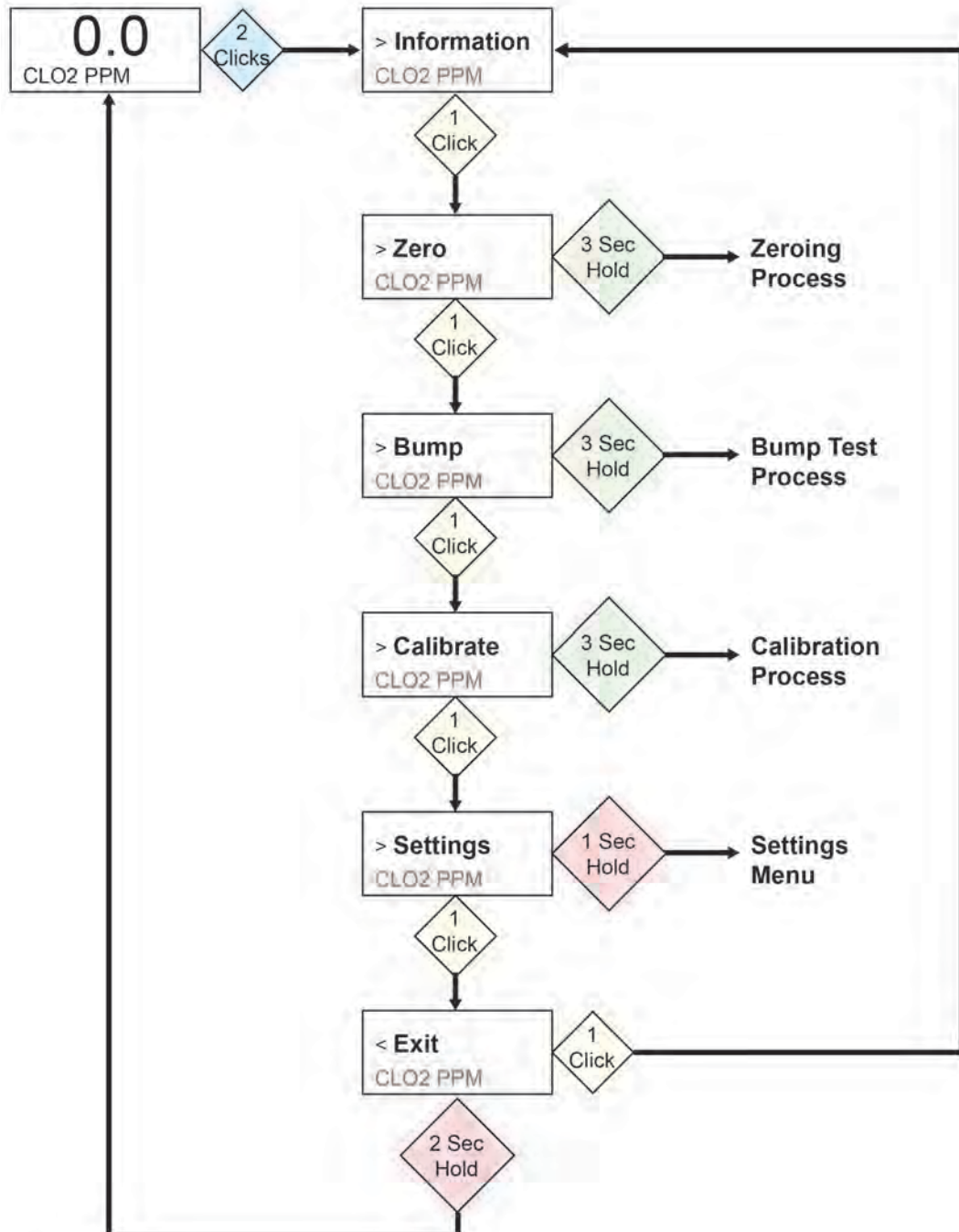

# Honeywell BW Solo User Manual

## 8. Navigation: Information Menu

Basic navigation of the Honeywell BW Solo Information menu allows you to step through screens to see settings and status. All are read-only information on a single screen, except for Event Log, which has its own navigation to show one or more events.

1. Start at the main screen and click the button twice in rapid succession to start.
2. When you see ">Information," hold the button for 1 second.
3. When the first screen, "Battery," is shown, you can progress through the screens by clicking the button once.

**Note:** When you reach the "Exit" screen, you can click once to cycle through the screens again, or you can exit by holding the button for 1 second.

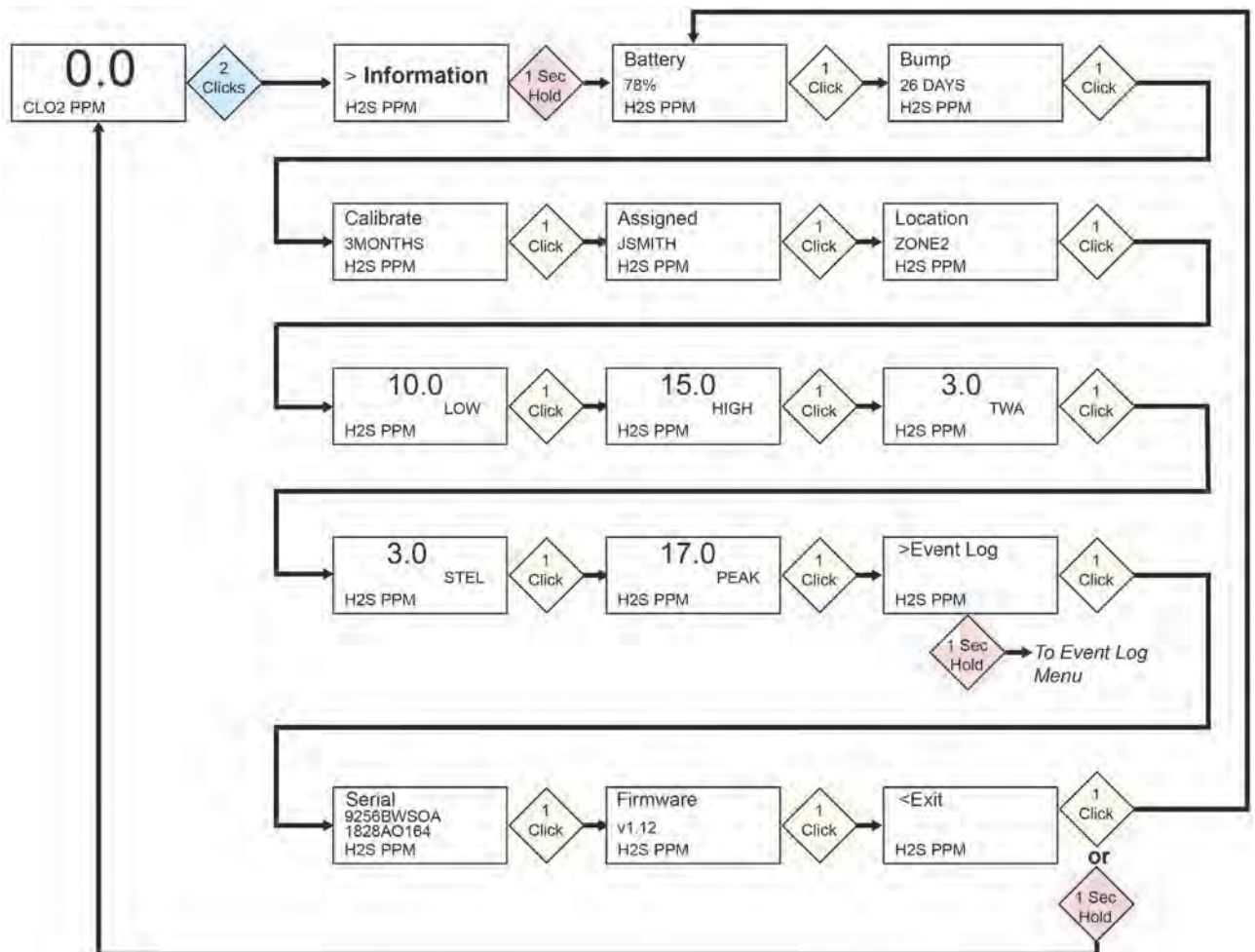

# Honeywell BW Solo User Manual

## 8.1. Event Log Navigation

**Note:** The Event Log is not present in the Information navigation for BW Solo monitors sold in North America.

The Event Log consists of a listing of events that have been captured.

To enter the Event Log from the Information menu, hold the button down for 1 second at the “>Event Log” prompt. There are three screens for each event, shown automatically in sequence from the date of the event to the start of the event to the conclusion of the event. It also shows the reading and the type of alarm (Low, High, etc.).

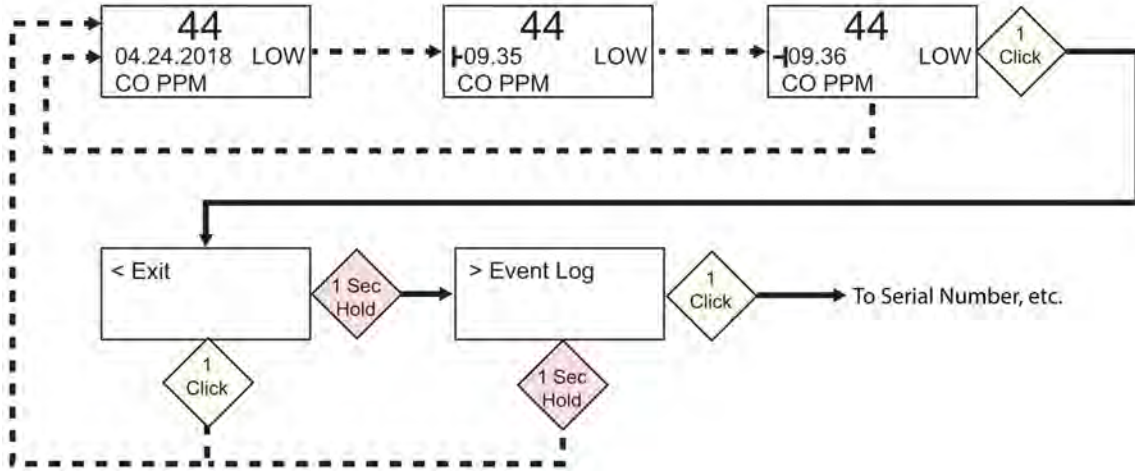

When there are multiple events in the Event Log, the screens cycle through a single event until you press the button. Each time you press the button, the next event is shown. When all events have been shown, the “<Exit” prompt is shown. To exit, hold the button for 1 second, and when the “>Event Log” prompt is shown, click the button once to exit to the next screen in the Information sequence, Serial Number.

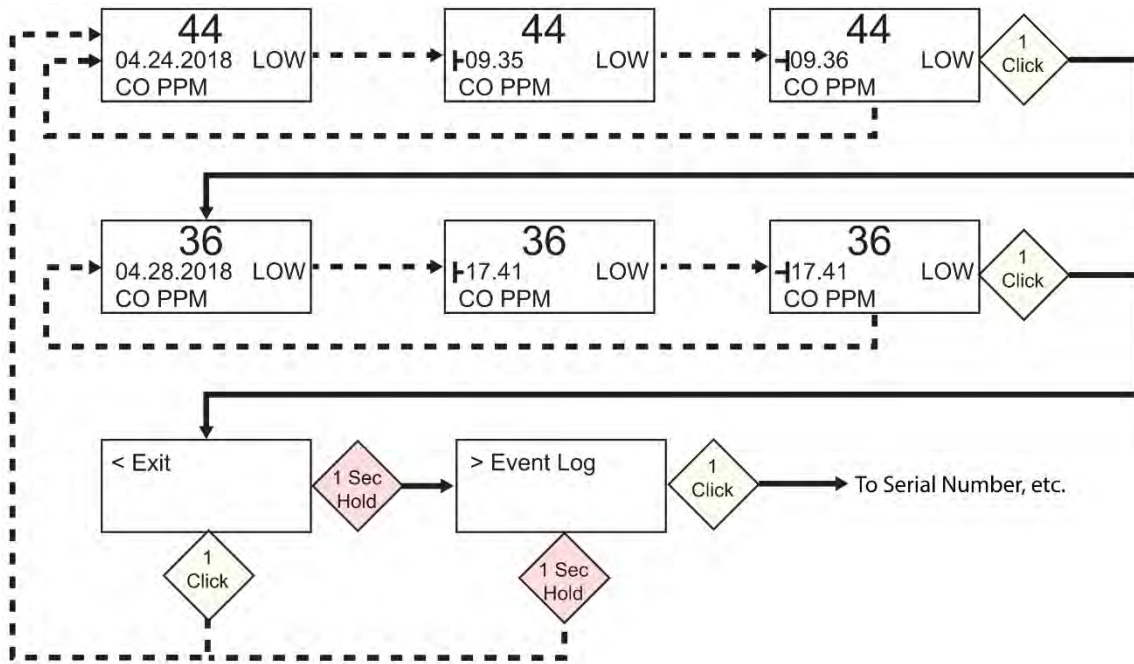



# Honeywell BW Solo User Manual

## 9. Navigation: Settings

The menu in Settings provides access to adjust settings. It has the following submenus:

- Language
- Time\*
- Date\*
- Units
- Readings
- Setpoints
- Latching
- Reminders
- Data Log\*
- BLE (wireless versions only)\*
- Assigned\*
- Zone\*
- IntelliFlash
- Non-compliance
- Passcode
- Exit

\* Not included on the BW Solo Lite version. Also, the Mute function under Latching is not included on the BW Solo Lite.

### 9.1. Enter Settings Mode

**Note:** A passcode can be required to access the settings menu. Setting an access restriction can be done using the Passcode submenu or by using an IntelliDoX with SafetySuite software.

To enter Settings from the main reading screen:

- Press the button twice in rapid succession. You should see “>Information”.
- Press the button again, four times, to reach “>Settings”.
- Press and hold the button for 1 second. You should see “>Language”. This is the first editable setting.

**Note:** If a passcode is required, input the 4-digit passcode (see section 9.17 for details). The instrument does not have this feature enabled out of the box.

# Honeywell BW Solo User Manual

## 9.2. Menus & Submenus In Settings Mode

Each Settings menu has a submenu of editable settings. All are accessed, changed, and saved in the same way:

1. Press the button once to step from one setting to the next.
2. When you find a setting to edit, hold the button for 1 second. The submenu for that setting is shown.
3. Press the button once to step from one menu option to the next.
4. When you find the option you want to select, press and hold the button.

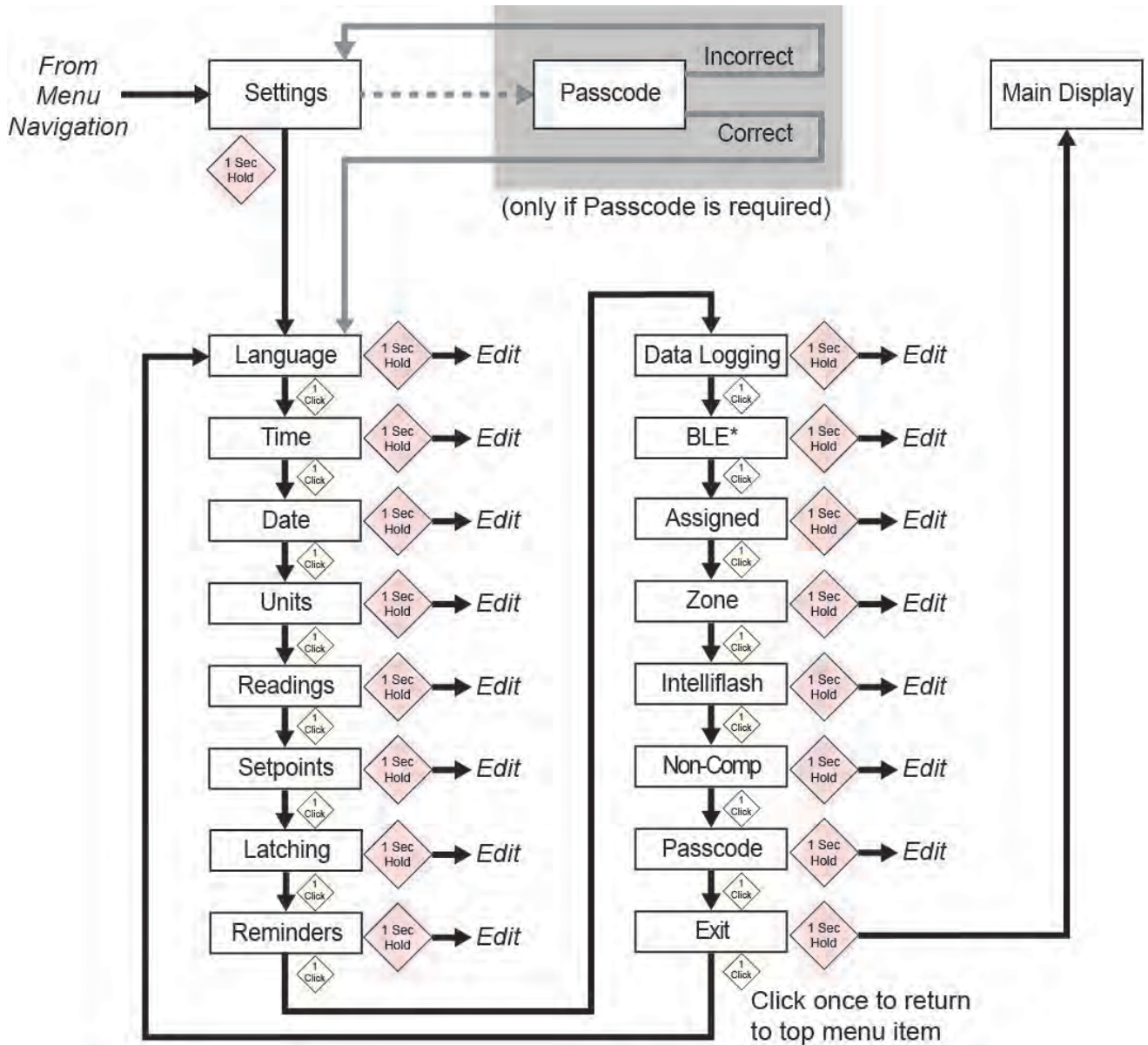

\* Only available on BLE-equipped instruments.

# Honeywell BW Solo User Manual

## 9.3. Language

English is the default language, but other languages can also be selected for the instrument. You can select any of the languages for viewing onscreen information. Navigate to a language and press the button for 1 second to select it.

**Note:** Language is initially set up during the out-of-the-box power-on sequence, but it can be changed at any time.

## 9.4. Time

Time can be in 12- or 24-hour format. The default is 24-hour format.

- Changing the time format to 12-hour adds an indicator of AM or PM.
- Single digits have a “0” prefix (for example, 01:15, 02:30, etc.)
- Click to cycle through the digits
- Press the button for 1 second to select it.

## 9.5. Date

The date can be shown in these formats (the default is MM.DD.YYYY):

- DD.MM.YYYY (Day.Month.Year)
- MM.DD.YYYY (Month.Day.Year)
- YYYY.MM.DD (Year.Month.Day)
- Single digits have a “0” prefix (for example, 01, 02, etc.).
- When entering the year, it loops in a range from 2018 to 2099 before returning to 2080.
- Press the button for 1 second to select each digit.

## 9.6. Units

The units of measure can be set as either ppm (parts per million), mg/m<sup>3</sup> (milligrams per cubic meter), µmol/mol (micromoles per mole), or other units appropriate to the sensor in use.

## 9.7. Readings

Reset the TWA and STEL readings here. Also, enable/disable Peak reading reset and perform action.

**Note:** The default value for the Peak reading is “disabled.” If it is enabled, there is an extra menu option that allows resetting the peak reading. If it is disabled, this menu option is hidden.

# Honeywell BW Solo User Manual

## 9.8. Setpoints

In Setpoints, you can assign setpoints for low alarm, high alarm, TWA, and STEL.

- Range entry is assigned four digits and two decimal places.
- Range entry is limited between 0000.01 and 9999.99 (determined by gas type).
- Number entry loops through a cycle from 0 to 9 (the range entry limit determines the loop for first digit entry and subsequent digits if the maximum is assigned).
- Press once to cycle through digits.
- Hold the button down for 1 second for confirmation to set each digit within the string.

## 9.9. Latching

The latch alarm option ensures that an alarm persists until it is acknowledged by the user.

If enabled, during an alarm condition the latched alarms option causes the low and high gas alarms (audible, visible, and vibrator) to persist until the gas concentration is below the alarm setpoint and the alarms have been acknowledged by pressing the button

You can turn latching on or off, and turn the mute option on or off. When the mute option is on, there is no sound when an alarm is latched. When latching is on and mute is off, if the instrument is still in a hazardous atmosphere, the real-time alarm will be displayed. When latching is on and mute is off, and the instrument is in a safe atmosphere, only the last gas alarm is displayed.

If the instrument is not in a hazardous atmosphere and you press the button to acknowledge, the latching alarm shuts off.

Besides turning latching on and off, you can turn the alarm mute on or off. **Note:** If latching the alarm is off, the option to “Mute” is hidden in the menu cycle.

The default setting for latching the alarm is off.

## 9.10. Reminders

Turn alert and force on or off, and set alert interval (in days) for bump and calibration.

Two separate menus are included for bump and calibration, and setting the interval. The “Interval” duration is set as day, and the maximum interval is 365 days. Setting the “Interval” range to 000 days turns the “Alert” feature off and hides the “Interval” setting.

- Click to cycle through “Interval” digits.
- Press for 1 second to confirm and set each digit of the “Interval” string.
- Press and hold the button for 3 seconds to confirm and toggle all reminder alerts to “off.”
- Press the button for 1 second for all other toggle cycle interactions, including turning the “Alert” reminder on.

### 9.10.1. Force On or Off for Bump/Cal

#### 9.10.1.1. Force Cal

When this feature is enabled, the display reads “Cal Now.” The user cannot pass this screen without calibration either manually or through IntelliDoX before proceeding to Idle Screen.

# Honeywell BW Solo User Manual

**For Manual Calibration:** At the “Cal Now” screen, press and hold the button to begin the process. Follow the calibration instructions. Once the Calibration has passed, the user may proceed to the idle screen. If calibration fails, then the instrument will revert to the “Cal Now” screen.

## 9.10.1.2. Force Bump

When this feature is enabled, the display reads “Bump Now.” The user cannot pass this screen without bump testing either manually or through IntelliDoX before proceeding to Idle Screen.

**For Manual Calibration:** Press and hold the button to start the bump process. Follow the instructions for the bump process. Once the bump test has passed, the user may proceed to the idle screen. If the bump test fails, then the instrument will revert to the “Bump Now” screen. If no action is taken, then the unit will automatically shut off after 60 seconds.

The default setting for bump and calibration reminders is off.

## 9.11. Data Logging

Turn datalogging on or off and set the frequency interval (in seconds) for data collection.

**Note:** Turning data logging off hides the “Interval” setting option. The default setting for “Interval” is 005 seconds, and the interval can be set between 001 and 300 seconds.

The default setting for data logging is on.

## 9.12. BLE

On instruments that feature BLE (Bluetooth Low Energy), turn BLE communication on or off, so that the instrument is discoverable or not discoverable.

Note: If BLE operation is desired, this option must be specified at time of order.

- When BLE is turned off, the BLE “off” icon is displayed.
- When BLE is turned on, the BLE “on” icon is displayed.

The default setting for BLE is on.

## 9.13. Assigned

The instrument can be assigned to a person, and their name can be programmed into it. You can also turn assignment on or off, or edit/rename an assignment. The name can be up to 10 characters long.

The following are available for entry:

- Digits 0 to 9
- Upper-case characters A to Z
- A space

## 9.14. Zone

A zone’s name can be programmed. You can turn location on or off, and name, edit, or rename it.

The following are available for entry:

# Honeywell BW Solo User Manual

- Digits 0 to 9
- Upper-case characters A to Z
- A space

## 9.15. IntelliFlash

IntelliFlash verifies operation and compliance by flashing the green LED on the top of the instrument at intervals you select. This indicator notifies you that the monitor has no fault conditions and that all required maintenance, such as bump test and calibration, has been performed.

You can turn IntelliFlash on or off. You can also turn the “beep” on or off and set the flash interval as 10, 30, or 60 seconds.

The default setting for IntelliFlash is off. The default interval is 30 seconds.

# Honeywell BW Solo User Manual

## 9.16. Non-Compliance Indicator LEDs

Non-Compliance is a user-settable option that flashes the red Non-Compliance Indicator LEDs around the perimeter when the instrument experiences the following.

- Gas Event
- Bump Due
- Calibration Due

Non-Compliance Indicator LEDs automatically come on, regardless of user configuration, for the following.

- Sensor Error
- Battery Error
- Calibration Error

Non-Compliance Indicator LEDs are designed to alert other people around the user that their unit is not in compliance. Users are also allowed to change the flash interval and initiate the audible seconds (10, 30, or 60 seconds). You can turn this indicator on or off for gas events, bump due, and calibration due. You can also turn “beep” on or off and set the interval (10, 30, or 60 seconds).

The default setting for the Non-Compliance feature is off. The default interval is 30 seconds.

1. The non-compliance setting is designed to alert the safety manager to acknowledge the gas event and remind them to download the data to check what happened.
2. Non-compliance events consist of Low, High, TWA, STEL, Negative, and Over Range status.
3. Gas event of non-compliance can be turned on or off.
4. When a gas alarm is dismissed, non-compliance indication will continue to indicate a gas event by non-compliance indication (flash or flash and chirp/10, 30 or 60 seconds).
5. When a gas alarm is dismissed, if latching alarm is turned on, the instrument will continue to alert alarm behavior (audible, visible, and vibration, once per second). After the button is pressed to acknowledge the latching alarm, if Gas Event in non-compliance settings is on, the instrument will continue to indicate a gas event.
6. Inserting the instrument in an IntelliDoX will clear the non-compliance indication (for gas event). Any time the instrument is inserted in an IntelliDoX, the event log should be recorded in the IntelliDoX. A manual bump test should clear the non-compliance indication for both gas event and bump test due. Also, a manual calibration should clear the NCI for both gas event and calibration due.

## 9.17. Passcode

By default, no passcode is required for access to the instrument’s settings. However, a 4-digit passcode can be set, which will prevent access to all settings. This can be set here or through Honeywell SafetySuite software. If a passcode is ever lost and the instrument cannot be accessed, contact Technical Support.

- Click once to advance the number (0, 1, 2, 3, etc.).
- Press and hold the button for 1 second to advance to the next digit.
- When the last digit is reached, press and hold the button for 1 second.
- Confirm by clicking the button once.

**Important!** If you forget your passcode, then contact Honeywell Technical Support.

## 9.18. Exit

# Honeywell BW Solo User Manual

## 10. Zeroing

Because usage environments vary, there are many factors that may affect the performance of the gas detector, including temperature and humidity changes as well as dust. If the ambient air is not clean, gas readings might be inaccurate. For optimal performance, zero the gas detector once every 24 hours or after changing of environmental conditions.

1. From the main reading screen, click the button twice in rapid succession to enter the menus.
2. Click the button until you see Zero.
3. Press and hold the button down for [verify this time, it is more than 1 sec] second. The instrument counts down and then performs a zero calibration.
4. A progress bar indicates that the instrument is being zeroed.
  - If the instrument passes zeroing, the message “Passed” appears.
  - If the instrument fails zeroing, the message “Failed” appears.

If the instrument passed the zero calibration, it automatically reverts to the main reading screen after 10 seconds.

## 11. Bump Testing

### **IMPORTANT! BUMP TEST THE MONITOR BEFORE EACH DAY’S USE**

Prior to each day’s use, every gas detection monitor should be bump tested to confirm the response of all sensors and activation of all alarms by exposing the monitor to a concentration of target gas that exceeds the low alarm set point. A bump test is also recommended if the monitor has been subjected to physical impact, liquid immersion, an Over Limit alarm event, or custody changes, or anytime the monitor’s performance is in doubt.

To ensure greatest accuracy and safety, only bump test and calibrate in a fresh air environment. The monitor should be calibrated every time it does not pass a bump test, but no less frequently than every six months, depending on use and exposure to gas and contamination, and its operational mode.

- Calibration intervals and bump test procedures may vary due to national legislation.
- Honeywell recommends using calibration gas cylinders containing the gas that is appropriate to the sensor you are using, and in the correct concentration.

1. From the main reading screen, click the button twice in rapid succession to enter the menus.
2. Click the button until you see Bump.
3. Press and hold the button down for 3 seconds. The instrument counts down and then performs an AVV (audible, visible, vibration alarm) test. You see “Passed” or “Failed” on the display.
4. Press and hold the button to acknowledge the results. You should see “Apply Gas?”
5. Press the button to initiate the test.



# Honeywell BW Solo User Manual

- Place the calibration cap over the Honeywell BW Solo, and hook the cap's left clip to the corresponding groove of the detector and press down on the tab to snap the right clip into place.

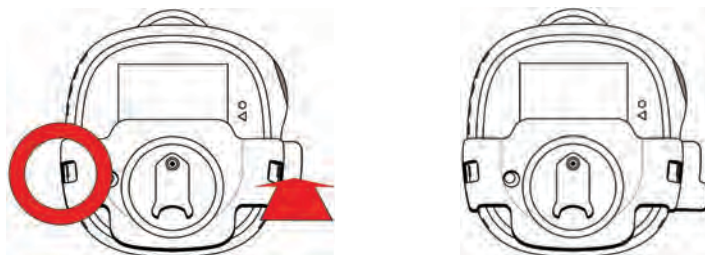

- If the hose is not connected to the calibration cap and the regulator on the calibration gas cylinder, attach it now.
- Open the cylinder valve by turning the pressure regulator knob counterclockwise.

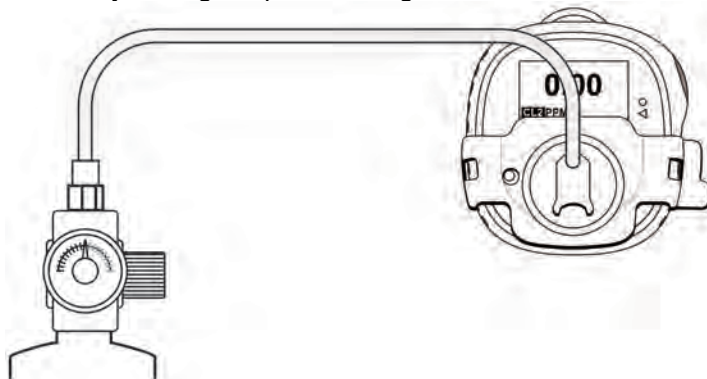

- Press and hold the button to initiate the bump test. A progress bar indicates that the bump test is happening.
  - If the instrument passes the bump test, the message "Passed" appears.
  - If the instrument fails the bump test, the message "Failed" appears.
- When "Turn Gas Off" appears, close the cylinder valve by turning the pressure regulator knob clockwise.
- Remove the calibration cap by pulling on the tab.

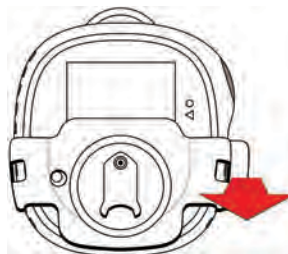

## IMPORTANT!

If the sensor does not pass a bump test, repeat the bump test. If it fails repeated bump tests, perform a full calibration. If it does not pass a full calibration, the sensor may need replacement. Do not use the instrument until it passes a full calibration.

# Honeywell BW Solo User Manual

## 12. Calibrating

1. Enter Calibration mode. From the main reading screen, click the button twice in rapid succession to enter the menus.
2. Click the button until you see Calibrate.
3. Place the calibration cap over the Honeywell BW Solo, and hook the cap's left clip to the corresponding groove of the detector and press down on the tab to snap the right clip into place.

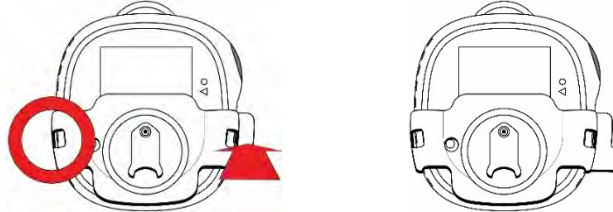

4. If the hose is not connected to the calibration cap and the regulator on the calibration gas cylinder, attach it now.
5. Hold down the button, and release after it says, "Zeroing." It performs a zero calibration.
6. When "Apply Gas" appears on the display, open the cylinder valve by turning the pressure regulator knob counterclockwise.

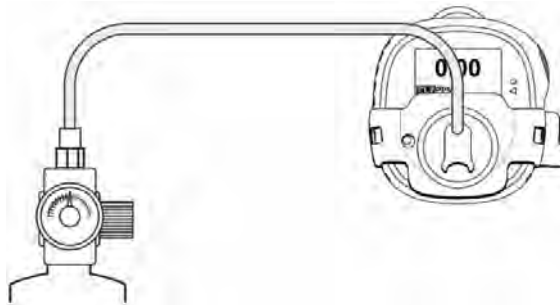

7. Start the calibration by pressing and holding the button for 1 second. The calibration is indicated by a progress bar, followed by "Passed" or "Failed." You can abort the calibration by clicking the button once.

### IMPORTANT!

If it fails calibration, try calibrating again. If it cannot calibrate after repeated tries, the sensor may need replacement or there may be a problem with the instrument. Do not use the instrument until the issue is resolved.

8. When "Turn Gas Off" appears, close the cylinder valve by turning the pressure regulator knob clockwise.
9. Remove the calibration cap by pulling on the tab.

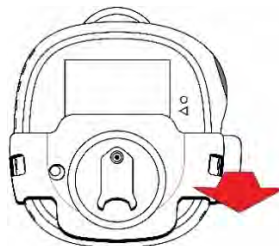

# Honeywell BW Solo User Manual

## IMPORTANT!

If the sensor does not pass a full calibration, the sensor may need replacement. Do not use the instrument until it passes a full calibration.

## 13. Replacing The Filter & Sensor

The sensor needs to be replaced when it is unable to be calibrated or behaves erratically. Also, the filter should be inspected periodically, and it should be replaced if it shows signs of accumulated dust, dirt, or debris.

### 13.1. Filter Color Reference

One of the holes in the sensor cover has a clear plastic window. While the other holes allow ambient air (and dirt, debris, etc.) to reach the filter, the window keeps the part of the filter under it clean. As a result, it is easy to visually confirm that the filter needs replacement by simply comparing the clean spot with the other spots.

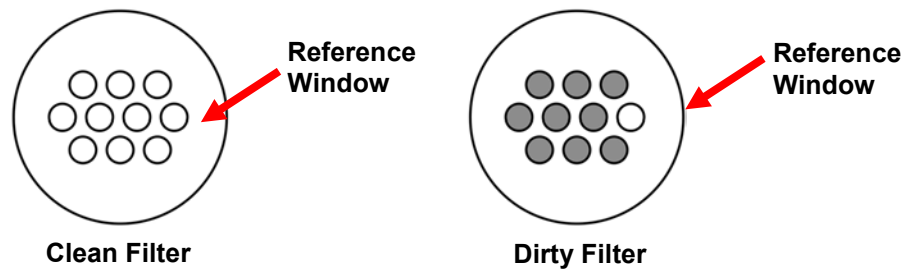

### 13.2. Removing The Cover

Remove the front cover by using the tab end of the calibration cap or a flat-blade screwdriver to pry it upwards from the slot. This exposes the sensor with its filter attached.

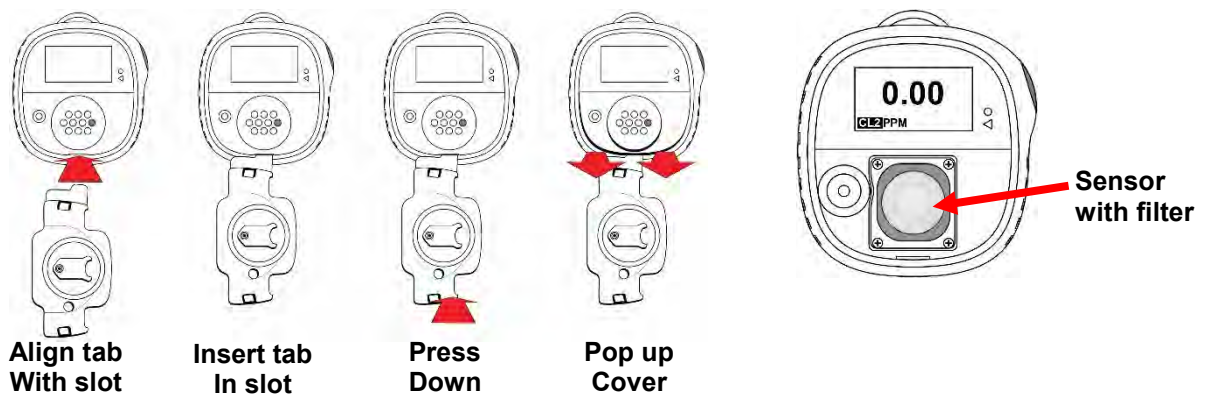

# Honeywell BW Solo User Manual

## 13.3. Replacing The Filter

If the filter appears dirty, replace it by peeling it off the sensor's top surface. Peel a new sensor from its protective paper and gently press it so it adheres evenly to the top perimeter of the sensor.

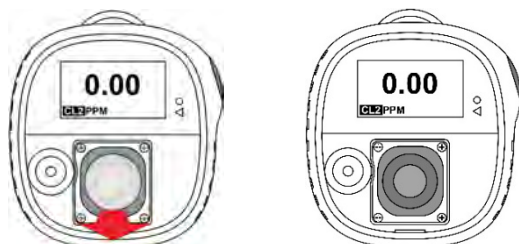

If the sensor does not need to be replaced, reinstall the cover.

Reinstall the front cover (see 13.5).

## 13.4. Replacing The Sensor

The sensor is held in place with a sensor frame and its four screws.

### **CAUTION!**

1. Turn off the instrument before replacing the sensor.
2. Only change the sensor in a safe area, free of hazardous gas.
3. Wear an ESD wrist or heel strap when replacing the sensor. Avoid touching electronic components on the detector printed circuit board or shorting circuits on the printed circuit board.
4. Use only the sensor specifically designed for the Honeywell BW Solo. Otherwise, the detector will not monitor the target gas.
5. Ensure that the sensor cover is properly aligned to ensure a proper environmental seal.
6. After replacing a sensor, allow the new sensor to stabilize the following amounts of time before use:

30 minutes: CO, H<sub>2</sub>S, CL<sub>2</sub>, H<sub>2</sub>, SO<sub>2</sub>, O<sub>3</sub>, PH<sub>3</sub>, NO<sub>2</sub>, ClO<sub>2</sub>, NH<sub>3</sub>

10 hours: CO-H, HCN

12 hours: O<sub>2</sub>, ETO, NO

Do not expose a sensor to vapors of organic solvents such as paint fumes or organic solvents.

7. Always calibrate the instrument after changing the sensor.

1. Remove the four screws holding the sensor frame in place.

# Honeywell BW Solo User Manual

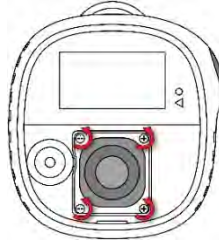

2. Lift off the sensor frame and (if present) the rubber spacer.
3. Pull the sensor straight out. Note the three sockets on the pcb for the sensor's electrodes for the 4-Series sensor type and the three contact points for the 1-Series sensor type.

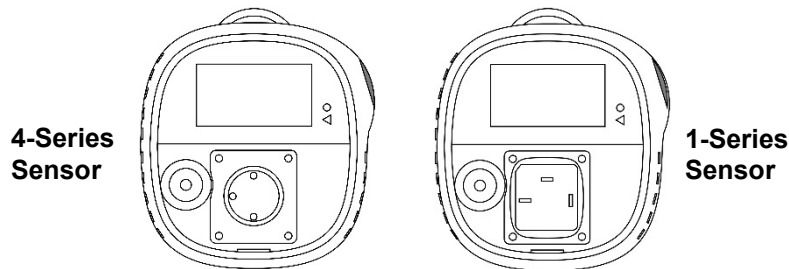

4. Remove the old sensor by pressing it out of the sensor frame.
5. Dispose of the old sensor properly.

Keep the O-ring (1-Series), or sealing ring (4-Series Series) for reuse it when installing the replacement sensor.

## 13.4.1. 4-Series Sensor Replacement

### IMPORTANT!

Some 4-Series sensors are shipped with a jumper that connects two of the pins. This jumper must be removed before installing the sensor. Turn the sensor upside-down, and slide the spring-tensioned jumper off of the sensor's pins. Properly dispose of the jumper.

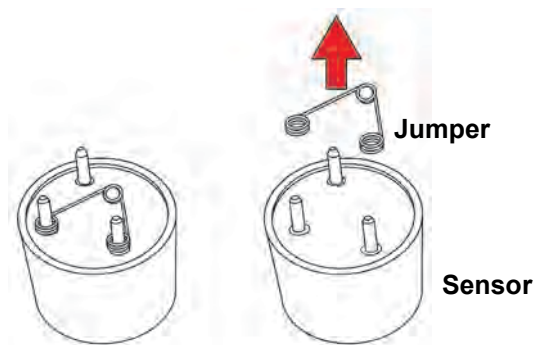

1. If the sensor is a 4-Series type, align the electrodes with the sockets on the printed circuit board and gently push it into place.

# Honeywell BW Solo User Manual

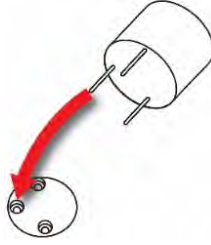

# Honeywell BW Solo User Manual

2. If not already done, place the metal insert inside the sealing ring, and then place that combination over the sensor, followed by the sensor frame over the spacer. Align the frame so that it fits properly around the audible alarm port. Tighten the screws to hold the frame in place. **Note:** Do not overtighten.

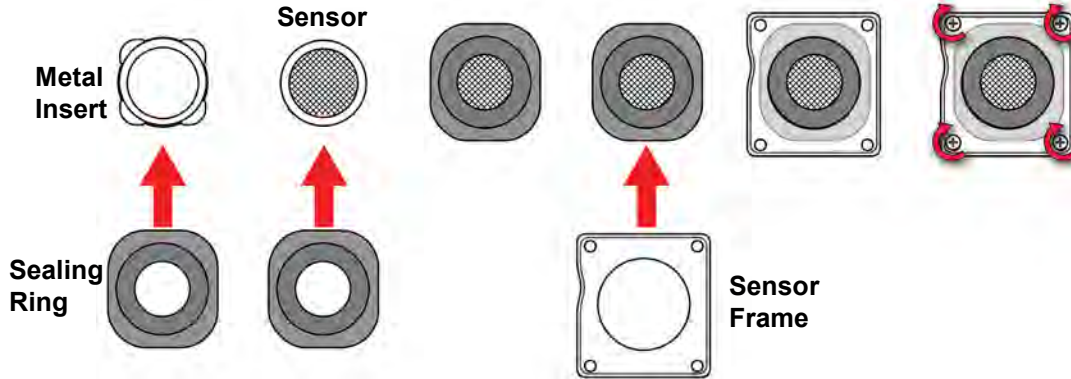

Install a new filter over the sensor before replacing the cover.

## 13.4.2. 1-Series Sensor Replacement

### IMPORTANT!

Some Series 1 sensors are shipped with a jumper that connects two of the pins. This jumper must be removed before installing the sensor. Turn the sensor upside-down, and slide the jumper off of the sensor's pins. Properly dispose of the jumper.

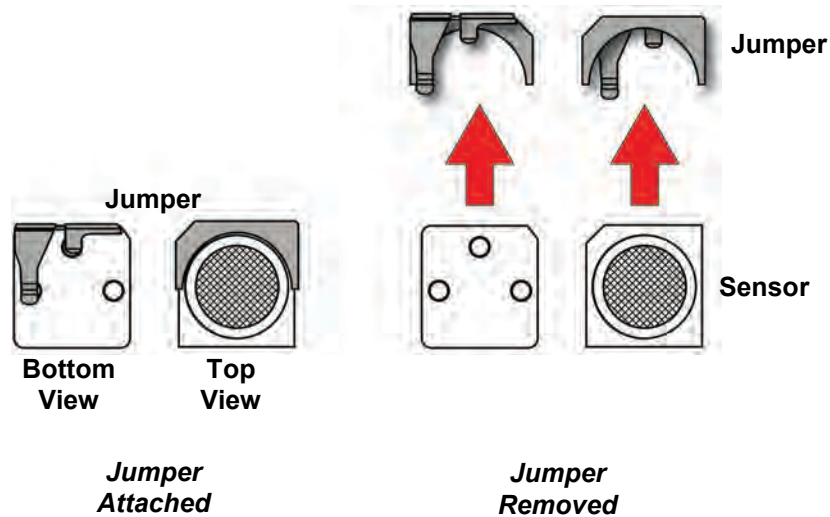

# Honeywell BW Solo User Manual

Invert the sensor so the three contacts are showing. Press the round part of the sensor into the sensor frame, aligning its notch with the matching part of the sensor frame's back. Invert the sensor and stretch the O-ring around the perimeter of the sensor.

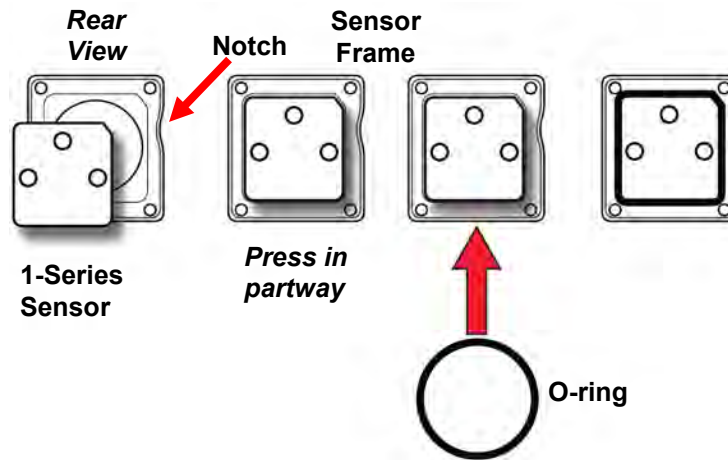

Invert the sensor, and press the sensor all the way until it is fully seated in the sensor frame.

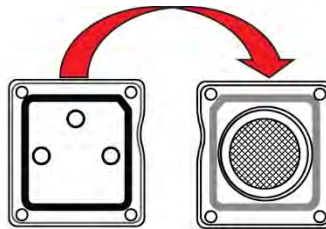

Insert the sensor assembly into the instrument.



Tighten the screws to secure the assembly in place. Do not overtighten the screws.



Install a new filter over the sensor before replacing the cover.



# Honeywell BW Solo User Manual

## 13.5. Reinstalling The Cover

To reinstall the cover, align it over the compartment, press upper part into place first, and then press the lower part until it clicks.

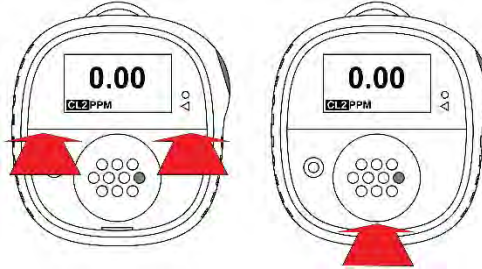

### **IMPORTANT!**

Always calibrate the instrument after you replace the sensor. Failure to calibrate the instrument can result in inaccurate readings. Some sensors require conditioning time before first use.

# Honeywell BW Solo User Manual

## 14. Maintenance

### 14.1. Cleaning

Occasional external cleaning of the instrument with a soft cloth is recommended. Do not use detergents or chemicals. (You may use water or a water-based or non-alcoholic cleaner. Other types of cleaners, solvents and lubricants can contaminate and cause permanent damage to the sensor.) Do not submerge the instrument in liquid. It is a good idea to install the Calibration Adapter before cleaning the housing, to keep dirt, dust, or moisture away from the sensor openings and to keep the filter clean.

**Note:** If the Honeywell BW Solo is to be used with an IntelliDox, make sure the infrared (IR) sensor on the rear of the instrument is clean to ensure best communication quality.

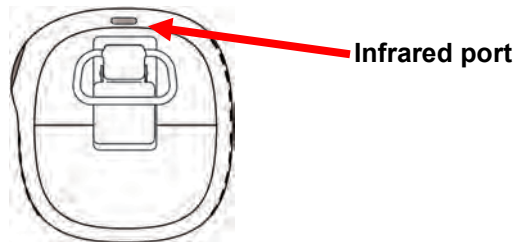

### 14.2. Replacing The Alligator Clip

If the alligator clip is damaged or loose, replace the combined alligator clip/battery door together.

### 14.3. Replacing/Serviceing Other Parts

Many interior components, including the display, vibration alarm, and horn gasket, are replaceable, but service should only be performed by qualified service personnel. **Note:** Attempting service may void your warranty.

## 15. Firmware Update

Firmware can be updated using an IntelliDoX docking station with SafetySuite software. For more information, refer to the IntelliDoX manual.

## 16. Year Of Manufacture

To identify the year and week of manufacture, refer to the four-digit marking adjacent to the serial number on the instrument label. It follows this number format:

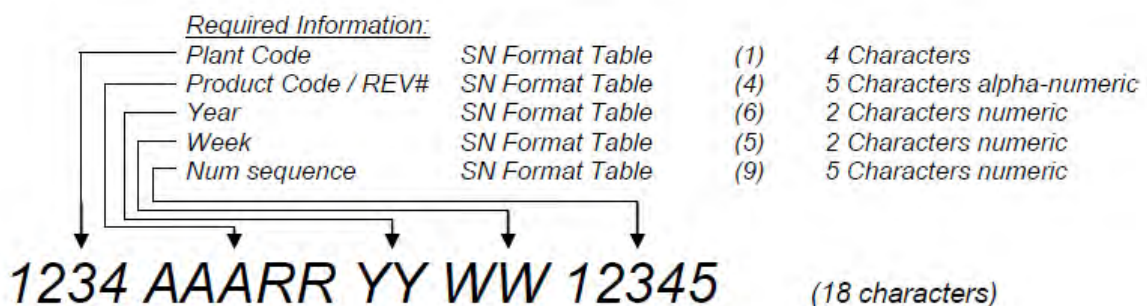

# Honeywell BW Solo User Manual

For example.: “9256 BWS 0A 18 30 00001” indicates that the instrument was manufactured in the 30th week of the year 2018.

## 17. Sensors & Settings

The available sensors and their range, resolution, temperature range, and low and high setpoints are shown here:

Gas Type	Range	Resolution	Temperature	Low Setpoint	High Setpoint
H <sub>2</sub> S*	0-200 ppm	0.1	-40 to +60° C/-40 to 140°F	10 ppm	15 ppm
CO*	0-2000 ppm	1 ppm	-40 to +60° C/-40 to 140°F	35 ppm	200 ppm
O <sub>2</sub> *	0-30% v/v	0.1 %v/v	-40 to +60° C/-40 to 140°F	19.5 %v/v	23.5 %v/v
H <sub>2</sub> S (extended range)	0-500 ppm	0.1*	-40 to +50° C/-40 to 122°F	10 ppm	15 ppm
CO-H	0-2000 ppm	0.5 ppm	-30 to +50° C/-22 to 122°F	35 ppm	200 ppm
NH <sub>3</sub>	0-100	1 ppm	-20 to +40° C/-4 to 104°F	25 ppm	50 ppm
NH <sub>3</sub> (extended range)	0-400	1 ppm	-20 to +40° C/-4 to 104°F	25 ppm	50 ppm
SO <sub>2</sub>	0-100 ppm	0.1 ppm	-30 to +50° C/-22 to 122°F	2 ppm	5 ppm
HCN	0-100 ppm	0.1 ppm	-20 to +50° C/-4 to 122°F	4.7 ppm	10 ppm
Cl <sub>2</sub>	0-50 ppm	0.1 ppm	-20 to +40° C/-4 to 104°F	0.5 ppm	1.0 ppm
NO	0-250 ppm	0.2 ppm	-30 to +50° C/-22 to 122°F	25 ppm	25 ppm
NO <sub>2</sub>	0-100 ppm	0.1 ppm	-20 to +50° C/-4 to 122°F	2 ppm	5 ppm
PH <sub>3</sub>	0-5 ppm	0.1 ppm	-20 to +50° C/-4 to 122°F	0.3ppm	1.0 ppm
ETO	0-100 ppm	0.1 ppm	-30 to +50° C/-22 to 122°F	1 ppm	5 ppm
ClO <sub>2</sub>	0-1 ppm	0.01 ppm	-20 to +40° C/-4 to 104°F	0.10 ppm	0.30 ppm
O <sub>3</sub>	0-1 ppm	0.01 ppm	-30 to +50° C/-22 to 122°F	0.10 ppm	0.20 ppm
H <sub>2</sub>	0-1000 ppm	2 ppm	-20 to +50° C/-4 to 122°F	100 ppm	500 ppm

\* 1-Series sensor

# Honeywell BW Solo User Manual

The following are available sensors for the Solo Lite (not available in North America):

Gas Type	Range	Resolution	Temperature	Low Setpoint	High Setpoint
H <sub>2</sub> S	0-100 ppm	0.1	-20 to +50° C/-4 to 122°F	10 ppm	15 ppm
CO	0-1000 ppm	1 ppm	-20 to +50° C/-4 to 140°F	35 ppm	200 ppm
O <sub>2</sub>	0-30% v/v	0.1 %v/v	-20 to +50° C/-4 to 140°F	19.5 %v/v	23.5 %v/v
H <sub>2</sub> S (extended range)	0-500 ppm	0.1*	-40 to +50° C/-40 to 122°F	10 ppm	15 ppm
CO-H	0-2000 ppm	0.5 ppm	-30 to +50° C/-22 to 122°F	35 ppm	200 ppm
NH <sub>3</sub>	0-100	1 ppm	-20 to +40° C/-4 to 104°F	25 ppm	50 ppm
NH <sub>3</sub> (extended range)	0-400	1 ppm	-20 to +40° C/-4 to 104°F	25 ppm	50 ppm
SO <sub>2</sub>	0-100 ppm	0.1 ppm	-30 to +50° C/-22 to 122°F	2 ppm	5 ppm
HCN	0-100 ppm	0.1 ppm	-20 to +50° C/-4 to 122°F	4.7 ppm	10 ppm
Cl <sub>2</sub>	0-50 ppm	0.1 ppm	-20 to +40° C/-4 to 104°F	0.5 ppm	1.0 ppm
NO	0-250 ppm	0.2 ppm	-30 to +50° C/-22 to 122°F	25 ppm	25 ppm
NO <sub>2</sub>	0-100 ppm	0.1 ppm	-20 to +50° C/-4 to 122°F	2 ppm	5 ppm
PH <sub>3</sub>	0-5 ppm	0.1 ppm	-20 to +50° C/-4 to 122°F	0.300 ppm	1.00 ppm
ETO	0-100 ppm	0.1 ppm	-30 to +50° C/-22 to 122°F	1 ppm	5 ppm
ClO <sub>2</sub>	0-1 ppm	0.01 ppm	-20 to +40° C/-4 to 104°F	0.10 ppm	0.30 ppm
O <sub>3</sub>	0-1 ppm	0.01 ppm	-30 to +50° C/-22 to 122°F	0.10 ppm	0.20 ppm
H <sub>2</sub>	0-1000 ppm	2 ppm	-20 to +50° C/-4 to 122°F	100 ppm	500 ppm

\* 1-Series sensor

# Honeywell BW Solo User Manual

## 18. Troubleshooting

If a problem occurs, refer to the solutions provided here. If the problem persists, contact Technical Support.

<b>Problem</b>	<b>Possible Cause</b>	<b>Solution</b>
The detector does not activate.	No battery.	Install a battery.
	Depleted battery.	Replace the battery.
	Damaged or defective detector.	Contact Technical Support.
	Reversed battery.	Reinstall the battery correctly.
The detector enters alarm mode immediately when it is activated.	Sensor needs to stabilize.	Used sensor: Wait 60 seconds. New sensor: Wait 5 minutes.
	Low battery alarm	Replace the battery.
	Sensor alarm	Replace the sensor.
The start-up self-test fails during one of the checks.	General fault	Contact Technical Support.
	Alarm setpoints are incorrect.	Reset the alarm setpoints.
The detector does not display a normal ambient gas reading after the activation self-test.	Target gas is present.	Detector is operating properly. Use caution in suspect areas
	Detector requires calibration	Calibrate the detector.
	Sensor not stabilized	Used sensor: Wait 60 seconds. New sensor: wait 5 minutes.
The detector does not respond to the pushbutton.	Battery is depleted.	Replace the battery.
	Detector is performing operations that do not require user input.	Pushbutton operation restores automatically when the operation ends.
The detector does not accurately measure the gas.	Detector requires calibration.	Calibrate the sensor.
	Detector is colder or hotter than the ambient gas.	Allow the detector to acquire ambient temperature before use.
	Sensor filter is blocked	Clean the sensor filter.
The detector does not enter alarm mode.	Incorrect setting of alarm setpoint(s).	Reset the alarm setpoints.
	Alarm setpoint(s) set to zero.	Reset the alarm setpoints.
	Detector is in calibration mode.	Complete the calibration.

# Honeywell BW Solo User Manual

## 19. Honeywell BW Solo Specifications



<b>Size</b>	2.74" H x 2.63" W x 1.42" D (69.7 x 66.7 x 36.1 mm) 1-Series sensor models 2.74" H x 2.63" W x 1.61" D (69.7 x 66.7 x 41 mm) 4-Series Series sensor models
<b>Weight</b>	3.56 oz. (101g) without Sensor/3.63~4.09 oz.(103~116g) with different sensors
<b>Sensor</b>	17 field-replaceable electrochemical sensors for toxics and oxygen
<b>Battery Options</b>	<ul style="list-style-type: none"> <li>ER14335 2/3AA lithium thionyl chloride battery (Over 1 year runtime)</li> </ul>
<b>Display</b>	<ul style="list-style-type: none"> <li>FSTN dot matrix LCD display (128 x 64) with backlighting (activated automatically with button press)</li> </ul>
<b>Display Readout</b>	<ul style="list-style-type: none"> <li>Real-time reading of gas concentrations; battery status; wireless on/off.</li> <li>Various instrument status-related information</li> </ul>
<b>Control</b>	1 button (single press, double press, short hold, long hold)
<b>Sampling</b>	Diffusion
<b>Calibration</b>	Automatic with IntelliDoX, or manual
<b>Alarms</b>	<ul style="list-style-type: none"> <li>Multi-tone audible (95 dB @ 30 cm/12"), vibration, visible (flashing bright red LEDs), and on-screen indication of alarm conditions</li> <li>Real-time remote alarm notification (Wireless Model Only).</li> </ul>
<b>Datalogging</b>	<ul style="list-style-type: none"> <li>Continuous datalogging (six months at 5 second intervals, running continuously)</li> <li>User-configurable datalogging interval (1 to 300 seconds)</li> </ul>
<b>Communication and Data Download</b>	<ul style="list-style-type: none"> <li>Data download and instrument setup and upgrades on PC via IntelliDoX or BLE (Wireless Model Only) or on cell phone via BLE (Wireless Model Only)</li> <li>Wireless data and status transmission via built-in BLE (Wireless Model Only).</li> </ul>
<b>Wireless Network</b>	BLE (Bluetooth Low Energy)
<b>Wireless Frequency</b>	Bluetooth 2402~2480MHz
<b>Wireless Approvals</b>	FCC ID: SU3BWS1 IC: 20969-BWS1 RE-D Directive 2014/53/EU
<b>Operating Temperature</b>	-40° to 140° F (-40° to 60° C) Refer to specific measurement operating range of different sensors.

Specifications subject to change

# Honeywell BW Solo User Manual

## Specifications

*continued*

<b>Humidity</b>	5% to 95% relative humidity (non-condensing) Refer to specific measurement operating range of different sensors
<b>Dust and Water Resistance</b>	IP66; IP68 1.2 meters for 45 minutes
<b>Certifications &amp; Approvals</b>	 Class I, Division 1, Groups A,B,C,D T4; Class I, Zone 0, AEx/Ex ia IIC T4 Ga -40°C ≤ Tamb ≤ 60°C  <b>ATEX:</b> Sira 18ATEX2243  2460  II 1G I M1 / Ex ia IIC T4 Ga Ex ia I Ma Tamb -40°C to 60°C  <b>IECEX:</b> IECEX SIR 18.0058, Ex ia IIC T4 Ga / Ex ia I Ma Tamb = -40°C to +60°C  <b>FCC ID:</b> SU38WS1  <b>IC:</b> 20969-BWS1  <b>RED:</b> RE-D Directive 2014/53/EU  For additional certifications, consult Honeywell Analytics.
<b>CE Compliance (European Conformity)</b>	EMC directive: 2014/30/EU RE directive: 2014/53/EU ATEX directive: 2014/34/EU
<b>FCC Compliance</b>	FCC Part 15
<b>Languages</b>	Chinese, Dutch, English, French, German, Italian, Japanese, Korean, Portuguese, Russian, Spanish
<b>Warranty</b>	<ul style="list-style-type: none"> <li>• 3 years for instruments equipped with 1-Series sensor</li> <li>• 2 years for instruments equipped with 4 Series sensor</li> <li>• 3 years for CO, H<sub>2</sub>S, O<sub>2</sub> 1-Series sensors</li> <li>• 2 years on 4 Series sensors, except for 1 year for Cl<sub>2</sub>, ClO<sub>2</sub>, NH<sub>3</sub>, O<sub>3</sub>, ETO</li> </ul>

Specifications subject to change

# Honeywell BW Solo User Manual

## 20. Limited Warranty and Limitation of Liability

Honeywell Analytics warrants the product to be free from defects in material and workmanship under normal use and service over the operational life of the device. This warranty extends only to the sale of new and unused products to the original buyer. Honeywell Analytics' warranty obligation is limited, at Honeywell Analytics' option, to refund of the purchase price, repair or replacement of a defective product that is returned to a Honeywell Analytics authorized service center within the warranty period. In no event shall Honeywell Analytics' liability hereunder exceed the purchase price actually paid by the buyer for the Product.

This warranty does not include:

- fuses, disposable batteries or the routine replacement of parts due to the normal wear and tear of the product arising from use;
- any product which in Honeywell Analytics' opinion, has been misused, altered, neglected or damaged, by accident or abnormal conditions of operation, handling or use;
- any damage or defects attributable to repair of the product by any person other than an authorized dealer, or the installation of unapproved parts on the product.

The obligations set forth in this warranty are conditional on:

- proper storage, installation, calibration, use, maintenance and compliance with the product manual instructions and any other applicable recommendations of Honeywell Analytics;
- the buyer promptly notifying Honeywell Analytics of any defect and, if required, promptly making the product available for correction. No goods shall be returned to Honeywell Analytics until receipt by the buyer of shipping instructions from Honeywell Analytics;
- the right of Honeywell Analytics to require that the buyer provide proof of purchase such as the original invoice, bill of sale or packing slip to establish that the product is within the warranty period.

THE BUYER AGREES THAT THIS WARRANTY IS THE BUYER' S SOLE AND EXCLUSIVE REMEDY AND IS IN LIEU OF ALL OTHER WARRANTIES, EXPRESS OR IMPLIED, INCLUDING BUT NOT LIMITED TO ANY IMPLIED WARRANTY OF MERCHANTABILITY OR FITNESS FOR A PARTICULAR PURPOSE. HONEYWELL ANALYTICS SHALL NOT BE LIABLE FOR ANY SPECIAL, INDIRECT, INCIDENTAL, OR BASED ON CONTRACT, TORT OR RELIANCE OR ANY OTHER THEORY.