



# GasPoint

Gas Transmitter

4-20 mA Fixed Gas Gas Monitor

Installation and Operating Instructions

**optimum**  
energy products ltd.

Toll Free: 1.877.766.5412

info@canarysense.com

Order this online 

CanarySense.com

"INNOVATORS IN GAS DETECTION"

**BW**  
Technologies



## Limited Warranty & Limitation of Liability

BW Technologies LP (BW) warrants this product to be free from defects in material and workmanship under normal use and service for a period of two years, beginning on the date of shipment to the buyer. This warranty extends only to the sale of new and unused products to the original buyer. BW's warranty obligation is limited, at BW's option, to refund of the purchase price, repair, or replacement of a defective product that is returned to a BW authorized service center within the warranty period. In no event shall BW's liability hereunder exceed the purchase price actually paid by the buyer for the Product.

This warranty does not include:

- a) fuses, disposable batteries or the routine replacement of parts due to the normal wear and tear of the product arising from use;
- b) any product which in BW's opinion, has been misused, altered, neglected or damaged by accident or abnormal conditions of operation, handling or use;
- c) any damage or defects attributable to repair of the product by any person other than an authorized dealer, or the installation of unapproved parts on the product; or

The obligations set forth in this warranty are conditional on:

- a) proper storage, installation, calibration, use, maintenance and compliance with the product manual instructions and any other applicable recommendations of BW;
- b) the buyer promptly notifying BW of any defect and, if required, promptly making the product available for correction. No goods shall be returned to BW until receipt by the buyer of shipping instructions from BW; and
- c) the right of BW to require that the buyer provide proof of purchase such as the original invoice, bill of sale or packing slip to establish that the product is within the warranty period.

THE BUYER AGREES THAT THIS WARRANTY IS THE BUYER'S SOLE AND EXCLUSIVE REMEDY AND IS IN LIEU OF ALL OTHER WARRANTIES, EXPRESS OR IMPLIED, INCLUDING BUT NOT LIMITED TO ANY IMPLIED WARRANTY OF MERCHANTABILITY OR FITNESS FOR A PARTICULAR PURPOSE. BW SHALL NOT BE LIABLE FOR ANY SPECIAL, INDIRECT, INCIDENTAL OR CONSEQUENTIAL DAMAGES OR LOSSES, INCLUDING LOSS OF DATA, WHETHER ARISING FROM BREACH OF WARRANTY OR BASED ON CONTRACT, TORT OR RELIANCE OR ANY OTHER THEORY.

Since some countries or states do not allow limitation of the term of an implied warranty, or exclusion or limitation of incidental or consequential damages, the limitations and exclusions of this warranty may not apply to every buyer. If any provision of this warranty is held invalid or unenforceable by a court of competent jurisdiction, such holding will not affect the validity or enforceability of any other provision.

BW Technologies LP  
2840 – 2nd Ave. SE  
Calgary, AB  
Canada T2A 7X9

BW America  
3279 West Pioneer Parkway  
Arlington, TX  
USA 76013

BW Europe  
5 Canada Close,  
Banbury, Oxfordshire  
United Kingdom OX16 2RT

# Table of Contents

Title	Page
Safety Information – Read First .....	v
Contacting BW Technologies.....	v
Manufacturer's Notes and Warnings .....	v
Introduction.....	1
Installation .....	3
Sensor Location .....	3
Mounting the Enclosure .....	4
System Design Specifications .....	5
Cable Installation .....	5
4-20 mA Loop Installation.....	6
Relay Cable Installation .....	6
Connecting the Controller and Power Supply .....	6
Remote Sensor Separation Kit.....	6
Mounting the Sensor Separation Kit Enclosure.....	8
Factory Settings.....	9
Dip Switch Overview.....	9
Changing the Alarm and Calibration Gas Setpoints.....	9
Dip Switch Settings.....	10
Connecting the Controller and Power Supply .....	11
Controller Calibration.....	11
Changing the Alarm Setpoints.....	12
Changing the Calibration Gas Concentration Level .....	12
Changing the Low Alarm Setpoint .....	12
Changing the High Alarm Setpoint .....	12
Operation.....	13
Gas Alarm Conditions and Advice .....	14
Fault Alarm Conditions and Advice .....	15
Calibration .....	16
Guidelines .....	16
Remote Calibration .....	16
Calibration Procedure .....	17
Maintenance.....	18
Cleaning a Sensor .....	18
Clearing a Sensor .....	18
Troubleshooting .....	18
Servicing the GasPoint .....	19
Sensor Assembly Replacement .....	19
Other Component Replacement.....	19
Specifications .....	20
Sensor Specifications .....	20
Relative Sensitivity of Combustible Gases/Vapors .....	21
Specifications.....	22
Replacement Parts and Accessories .....	23



## List of Tables

<b>Table</b>	<b>Title</b>	<b>Page</b>
1.	Ratings and Certification.....	1
2.	GasPoint Monitor .....	2
3.	Control Bay .....	2
4.	Liquid Crystal Display .....	2
5.	Transmitter with Catalytic/IR Combustible Sensor .....	5
6.	Transmitter with Toxic/Oxygen Sensor.....	5
7.	Distances for Sensor Separation Kit.....	6
8.	Factory Default Settings; Select Measuring Ranges.....	9
9.	Dip Switches .....	10
10.	Alarms .....	14
11.	Fault Conditions .....	15
12.	Calibration Diagnostics Protection.....	16
13.	Troubleshooting Tips .....	18
14.	Sensor Wiring Configuration.....	19
15.	GasPoint Replacement Parts .....	19
16.	Operating and Calibration Specifications .....	20
17.	Catalytic Sensor Relative Sensitivity of Common Combustible Gases/Vapors .....	21
18.	Standard Model IR GasPoint Relative Sensitivity to Applicable Combustible Gases/Vapors .....	21

## List of Figures

<b>Figure</b>	<b>Title</b>	<b>Page</b>
1.	GasPoint Monitor .....	2
2.	User Interface .....	2
3.	Liquid Crystal Display .....	2
4.	Outline Drawing .....	4
5.	System Wiring Diagram .....	7
6.	Sensor separation Kit Wiring Diagram .....	8
7.	Applying Gas to the Sensor .....	16
8.	Assembly Drawing .....	19
9.	Sensor Wiring Diagram.....	19



## Safety Information – Read First

### IMPORTANT

Users of the GasPoint (“the transmitter”) require a full understanding of the operating and maintenance instructions. Use the transmitter only as specified in this manual, otherwise the protection provided by the transmitter may be impaired. Read the following **Warnings** and **Cautions** before using the transmitter.

#### ⚠ Warnings

- ⇒ Do not paint the sensor assembly or the transmitter.
- ⇒ Calibrate the transmitter at start-up and BW recommends a calibration check on a regular schedule, once at least every 90 days. More frequent checks or inspections are encouraged to spot problems such as mud collections on the sensor head, accidental painting over the sensor head, etc.
- ⇒ Do not use the transmitter if it is damaged. Before you use the monitor, inspect the case. Look for cracks or missing metals or plastics. If the transmitter is damaged or something is missing, [contact BW Technologies](#) immediately.
- ⇒ Make sure the cover is properly fastened before you operate the transmitter.
- ⇒ Use only a sensor assembly specifically designed for your GasPoint model. Refer to [Replacement Parts and Accessories](#).
- ⇒ Periodically test the sensor’s response to gas by exposing the monitor to a targeted gas concentration that exceeds the high alarm setpoint. Manually verify that visual alarms are activated.
- ⇒ Opening the sensor will invalidate the calibration.

#### ⚠ Cautions

- ⇒ Do not expose the monitor to electrical shock and/or severe continuous mechanical shock.
- ⇒ Do not attempt to disassemble, adjust, or service the monitor unless instructions for that procedure are contained in the manual and/or that part is listed as a [replacement part](#).
- ⇒ Do not allow liquids to condense and/or use high power sprays on the instrument.
- ⇒ The warranty will be voided if customer personnel or third parties damage the monitor during repair attempts. Non-BW Technologies repair/service attempts void this warranty.

### IMPORTANT

The GasPoint is only to be used for the purposes specified in this manual. BW Technologies’ authorized service representatives and parts must be employed in carrying out repairs to the unit in order to maintain the validity of the warranty. Modification of components, use of non-BW parts, or use of incomplete or used parts will also invalidate the warranty.

**CAUTION:** FOR SAFETY REASONS THIS EQUIPMENT MUST BE OPERATED AND SERVICED BY QUALIFIED PERSONNEL ONLY. READ AND UNDERSTAND INSTRUCTION MANUAL COMPLETELY BEFORE OPERATING OR SERVICING.

## Contacting BW Technologies

To contact BW Technologies, call:  
USA: 1-888-749-8878  
Canada: 1-800-663-4164  
Europe: +44 (0) 1295 700300  
Other countries: +1-403-248-9226

Address correspondence to:  
**BW Technologies LP**  
**2840 – 2 Avenue S.E.**  
**Calgary, AB T2A 7X9**  
**CANADA**  
ISO 9001

Email us at: [info@bwt.net](mailto:info@bwt.net)  
Visit BW Technologies’ website at: [www.gasmonitors.com](http://www.gasmonitors.com)

## Manufacturer’s Notes and Warnings

1. Read the Safety Warnings and Cautions at the beginning of this manual.
2. The GasPoint is fully tested and calibrated in the factory. Installation of the GasPoint should be done by qualified personnel



## Introduction

The GasPoint (“the transmitter”) provides continuous monitoring of the atmosphere for hazardous gases in the workplace and is virtually maintenance-free. Its revolutionary design utilizes advanced microcontrollers and allows for enhanced diagnostics and fault analysis. Advanced design features make installation and operation simpler than ever, saving you time and money.

The transmitter provides a 4-20 mA output signal which can be connected to any control system (DCS, PLC, etc.). Designed with non-volatile memory, the transmitter has total memory retention.

The pushbutton, non-intrusive calibration can be easily performed by one person with no tools or magnet keys. Normally, only a periodic calibration check is needed to assure dependable performance. The backlight automatically activates in low light conditions and in an alarm condition.

The LCD is an intuitive user interface, indicating the following:

- When a toxic or combustible sensor has “failed” its self-test;
- Gas type monitored and concentration level (%LEL or ppm);
- Alarm level (field settable) and the type encountered (low, high, or fault);
- When to apply gas during calibration; and
- When a toxic or combustible sensor has “failed” its self-test.

The flexibility of the transmitter’s modular design affords efficient installation. Wiring of the transmitter itself is straightforward. Field interchangeable plug-in sensor assemblies enable the user to change the gas monitored at any time. The transmitter recognizes the sensor installed and tests and resets itself to that sensor type.

The poison-resistant sensors have the fastest response times available. The transmitter is capable of responding to a momentary puff of gas that would otherwise remain undetected. The sensors have a proven history of reliable, long-term performance and are relatively unaffected by temperature or humidity variations. Gas enters the transmitter’s sensor by convection and diffusion through a sintered stainless steel or wire-mesh screened opening.

The transmitter’s explosion-proof design allows operation in areas where the combustible gas concentration may exceed the lower-explosive limit (LEL). Its rugged construction ensures a long life span in almost any environment.

The transmitter incorporates the best of both proven and new technologies that offer versatility in addition to reliable safety mechanisms.

**Table 1. Ratings and Certification**

	<p>All gases, except Cl<sub>2</sub>, ClO<sub>2</sub>, and HCl          Approved by CSA (Canadian Standards Association) for use in both the USA and Canada          Class I, Div. 1, Groups B, C, D          Class II, Groups E, F, G (Toxic only)          Combustible Performance Standards: ANSI/ISA. ISA—S12.13          CSA: C22.2 No 152</p>
	<p>GasPoint Cl<sub>2</sub>, ClO<sub>2</sub>, and HCl          Approved by CSA (Canadian Standards Association) for use in both the USA and Canada for ordinary locations</p>
<p>Approved Non-Incendive for installations in Class I, Division 2, Groups B, C, D          Location's when both input power and relay outputs are connected to non-incendive sources not to exceed          32 Vdc (power input) and 24 Vdc (relay output)          CSA: C22.2 No.213, UL: 1604</p>	

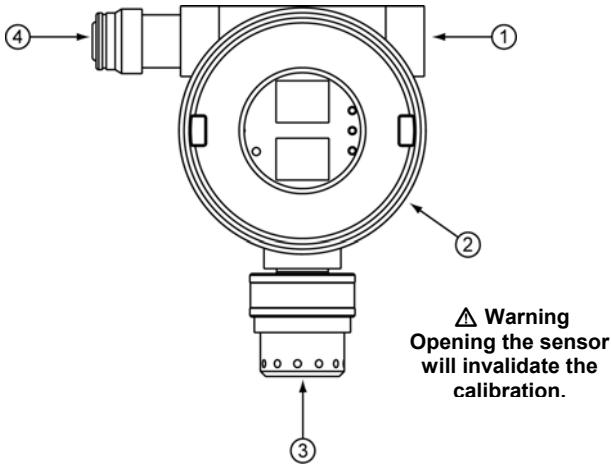

Figure 1. GasPoint Monitor

Table 2. GasPoint Monitor

Item	Description
1	Cable conduit access
2	Explosion-proof enclosure
3	Sensor
4	Calibration pushbutton

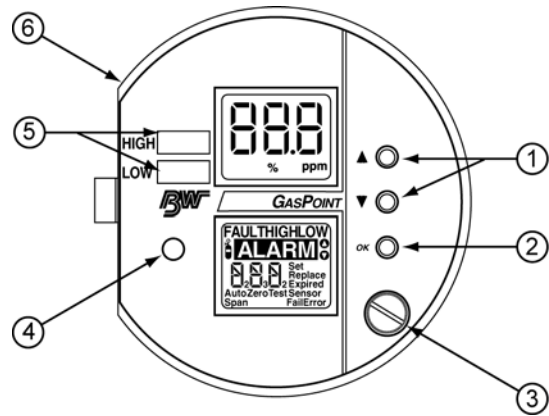

Figure 2. User Interface

Table 3. Control Bay

Item	Description
1	Edit buttons
2	OK button
3	Faceplate security screw
4	Low light sensor
5	High/Low alarm settings
6	Slip Hinge

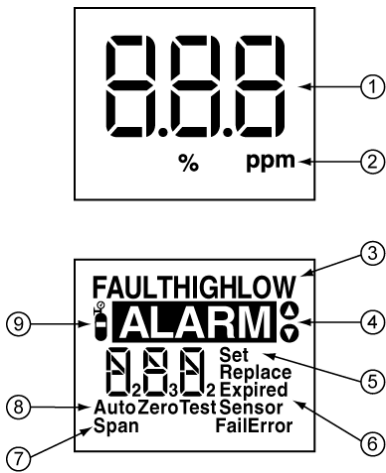

Figure 3. Liquid Crystal Display

Table 4. Liquid Crystal Display

Item	Description
1	Numeric reading
2	Units of measure (ppm or %)
3	Alarm level/type
4	Increment/decrement prompt arrows
5	Set value arrow prompts
6	Sensor advice
7	Span advise icon
8	Automatic zero advise icon
9	Apply gas advise icon

## **Installation**

### **Sensor Location**

Several factors should be considered when selecting locations to install sensors. The following general suggestions should be considered to assure the detection of the target gas. Select the most suitable location for each sensor.

**Air Currents:** If there are fans, wind, or other sources of air movement, gases may tend to rise or collect in certain areas of a facility. The local air currents should be assessed to aid in selecting the sensor location. Outdoor situation considerations, such as prevailing winds, should also be accounted for. Air convection can often be more important in determining gas concentrated areas than factors of vapor density.

**Vapor Density:** When there are no air currents in the area, sensor placement may be affected where the gas (vapor) to be monitored is lighter or heavier than air. For gases lighter than air, BW suggests placing the sensor approximately 12 in. (30 cm) above the level of a potential gas release, or close to the ceiling or roof in indoor installation. For gases heavier than air, BW suggests placing the sensor 12 in. (30 cm) below the release site, or near the floor or ground. Gases with a density equal to air or slightly greater than air tend to rise (particularly when air currents are present).

**Gas Emission Sources:** As a rule, at least one sensor should be located in close proximity to each point where a leak is likely to occur. This is particularly important when a liquid with a low volatility is being monitored.

**Environmental Factors:** Designed for rugged outdoor use, consider the following in selecting a location.

- Install sensors where they are protected from wind, dust, snow, water, vibration, and/or shock.
- Observe the operating temperature range of the sensor. Refer to [Sensor Specifications](#).

### Mounting the Enclosure

Modular design simplifies the installation of the transmitter. The transmitter's main board is mounted to the inner control door, which is equipped with slip hinges. The transmitter's back enclosure contains the relays and power board and is equipped with a threaded 3/4 inch NPT conduit fitting outlet and pre-drilled mounting flanges. Power and signal lines connect to the plug-in terminal block on the power board. The transmitter may be disassembled, simplifying the installation.

**⚠ Caution: Qualified personnel should perform the installation according to applicable electrical codes, regulations, and safety standards. Ensure correct cabling and sealing fitting practices are implemented.**

Install the transmitter. The predrilled mounting flanges: I.D. 0.25 on 5.5 inch centers.

It is preferable to attach the transmitter to a wall or bracket, using bolts through the two mounting holes. These mountings, however, may be omitted if the electrical conduit is sufficiently rigid to support the weight of the transmitter.

**Note:** The sensor should never be installed pointed upwards.

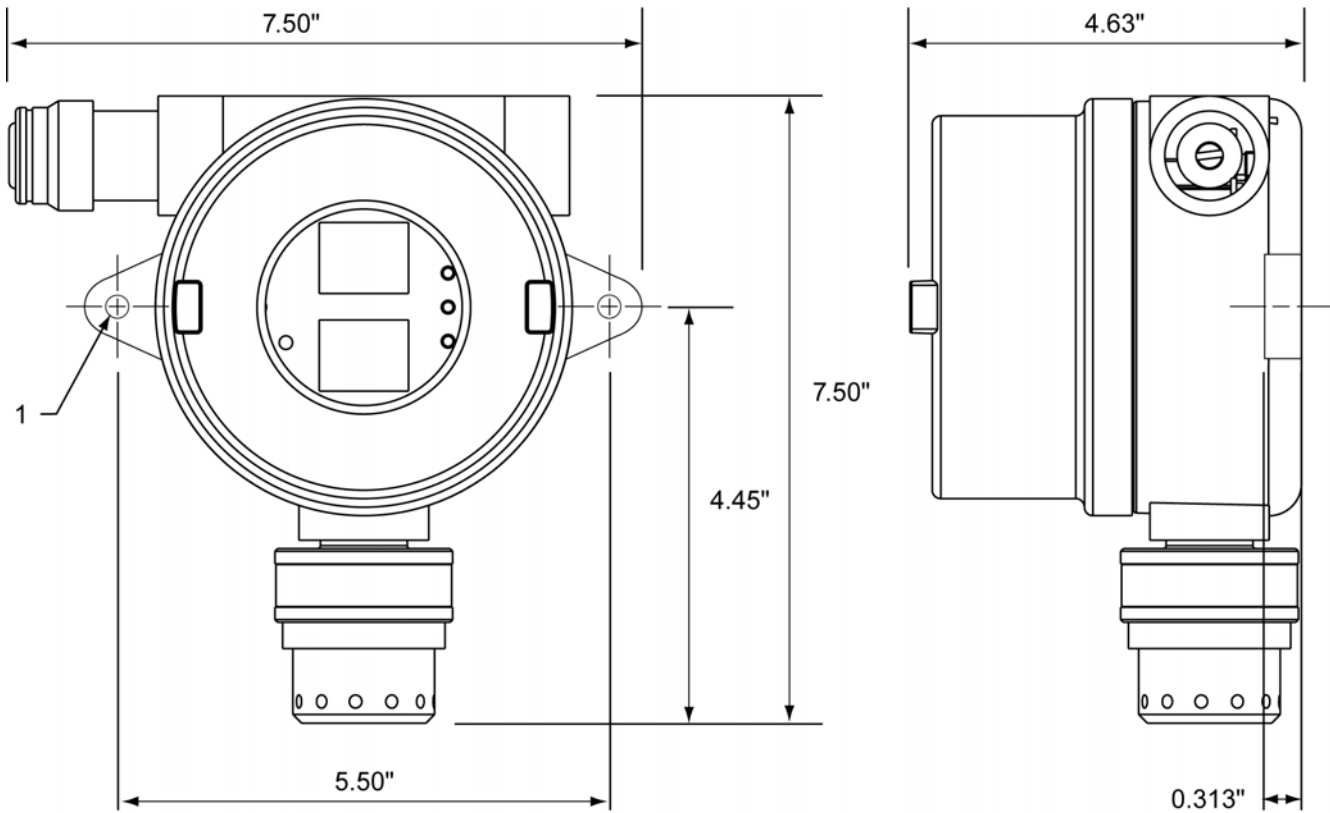

Figure 4. Outline Drawing

**System Design Specifications**

- Supply Voltage:** 12 to 32 volts  
**Power Consumption:** Catalytic Combustible Sensors: 100 mA @ 24 Vdc  
 IR Combustible Sensors: 75 mA @ 24 Vdc  
 Toxic/Oxygen Sensors: 40 mA @ 24 Vdc  
 Relays: 50 mA per relay (150 mA total)  
**Memory:** Non-volatile memory, a battery back-up is not necessary to retain values in the event of power outages.  
**Loop Resistance:** 650 ohms maximum  
**Cable:** 4-20 mA: 3 conductor, 14 to 24 AWG; Relays: 3 conductor, 14 to 24 AWG  
 Sensor Separation Kit: 4 conductor, 16 to 22 AWG  
**Relays:** 5 amp at 24 Vdc or 115 Vac SPDT; low, high, and fault  
 Low/High Relays: Field selectable for normally energized/de-energized; latching/non-latching  
 Fault Relay: Energized; non-latching  
**Sensor Separation Kit:** Transmission distances (see tables below)

**Cable Installation**

**Transmission Range:** The distance the 4-20 mA signal can travel is dependent on several factors including the cable gauge. Maximum cable resistance is 650 ohms less the controller resistance.

The tables below assume a constant 24 volt power supply (at 20°C) copper wire and a controller resistance of 250 ohms. The signal range from the controller to the transmitter takes into account the return loop.

**Note:** The BW CR-4000 Controller has a resistance of only 120 ohms.

**Table 5. Transmitter with Catalytic/IR Combustible Sensor**

(Maximum cable lengths between the controller and transmitter)

Conductor Size		Relays Not Used		One Relay Connected		Two Relays Connected		Three Relays Connected	
Sq mm	AWG	feet	meters	feet	meters	feet	meters	feet	meters
0.64	22	3,356	1,022	2,368	722	1,830	557	1,491	454
0.75	20	5,336	1,626	3,767	1,148	2,910	887	2,371	722
1.0	18	8,476	2,583	5,983	1,823	4,623	1,409	3,767	1,148
1.5	16	13,474	4,106	9,511	4,106	7,749	2,240	5,988	1,825
I <sub>c</sub> Current Factor		0.12		0.17		0.23		0.28	

**Table 6. Transmitter with Toxic/Oxygen Sensor**

(Maximum cable lengths between the controller and transmitter)

Conductor Size		Relays Not Used		One Relay Connected		Two Relays Connected		Three Relays Connected	
Sq mm	AWG	feet	meters	feet	meters	feet	meters	feet	meters
0.64	22	6,712	2,045	3,661	1,115	2,517	767	1,917	584
0.75	20	10,953	3,253	5,821	1,774	4,002	1,219	3,049	929
1.0	18	16,953	5,167	9,247	2,818	6,357	1,937	4,843	1,476
1.5	16	26,948	8,213	14,699	8,213	10,105	3,080	7,699	2,346
I <sub>c</sub> Current Factor		0.06		0.110		0.160		0.210	

For other operating parameters use the formula below to establish the transmission range.

Formula: Maximum distance =  $\frac{((V_p - V_T) / I_c) - R_C}{2 \times R_L}$

where:

- V<sub>p</sub> = power supply voltage (minimum)
- V<sub>T</sub> = transmitter supply voltage (minimum) 12 volt
- I<sub>c</sub> = current through conductor (See Table 5 and 6 for factors)
- R<sub>C</sub> = total controller resistance
- R<sub>L</sub> = line resistance per 350 m (1,160 ft.)

### 4-20 mA Loop Installation

**Cable Routing:** Separate cables are required for each transmitter. In classified areas the cable should be in conduit or it should be an approved hazardous location cable.

**Power Supply:** Ensure power supply meets the minimum requirements of all components of your system (i.e., alarms, relays, etc.). BW recommends that the power supply be regulated.

**⚠ Caution: Polarity must be observed. If the Return and +24 volt wires are reversed, the transmitter will not work. Do not apply electrical power to the transmitter until all connections are made, the sensor is in place, and the transmitter is complete.**

1. Remove the transmitter cover, open the inner hinged control door and remove, if desired.
2. Attach the conduit, if applicable, and pull cable(s) into the enclosure.
3. Connect the 3-pin power terminal block.

Return (R): 4-20 mA signal to the labeled terminal  
Supply (V): (+) positive (12-32 volts) to the labeled terminal  
Ground (G): Ground wire to the labeled terminal

**Note:** (If using shielded cable) To avoid radio frequency interference (RFI), the shield (including Mylar) must be grounded. Simply tying a bare drain wire to ground does not ground a shield. Keeping the shield as short as possible, tie the shield to the internal grounding screw. Tie any unused wires to ground.

### Relay Cable Installation

The transmitter is equipped with three relays: low gas alarm, high gas alarm, and fault alarm. Select to connect the applicable relays required in each situation. Relay connections are labeled: NO (normally open), C (common), and NC (normally closed). Attach wires as required to the applicable terminals.

**Note:** The fault relay connections are reversed.

Set the alarm dip switches before applying power. Once power is applied, if desired, change the alarm setpoints.

### Connecting the Controller and Power Supply

Ensure the transmitter's external cover is in place before applying power. Follow the procedures and recommendations in the control systems manual to complete the installation.

1. Ensure the transmitter is tied to the controller ground, to the earth ground, and to the negative terminal of the power supply.
2. Attach wires to the controller and power supply as shown in the wiring diagram. Refer to Figure 5.

### Remote Sensor Separation Kit

The transmitter sensor separation kit can be mounted at the following distances dependent of the cable size.

Table 7. Distances for Sensor Separation Kit

Conductor Size		Catalytic/IR Combustible Sensor		Toxic/O <sub>2</sub> Sensor	
Sq mm	AWG	feet	meters	feet	meters
0.64	22	619	188.5	1,548	472
0.75	20	985	300	2,463	750
1.0	18	1,564	476	3,912	1,174
1.5	16	2,487	758	6,218	1,895

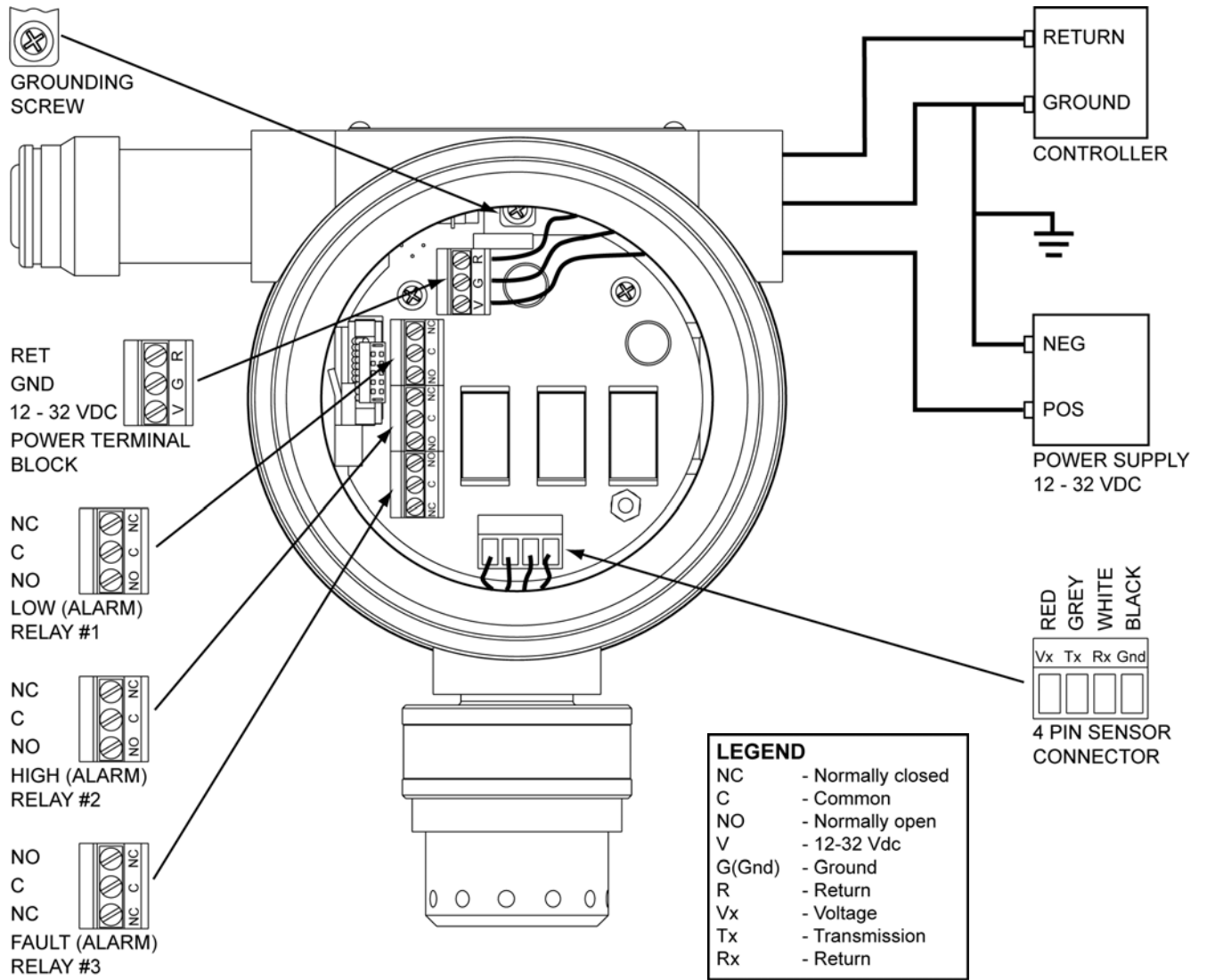
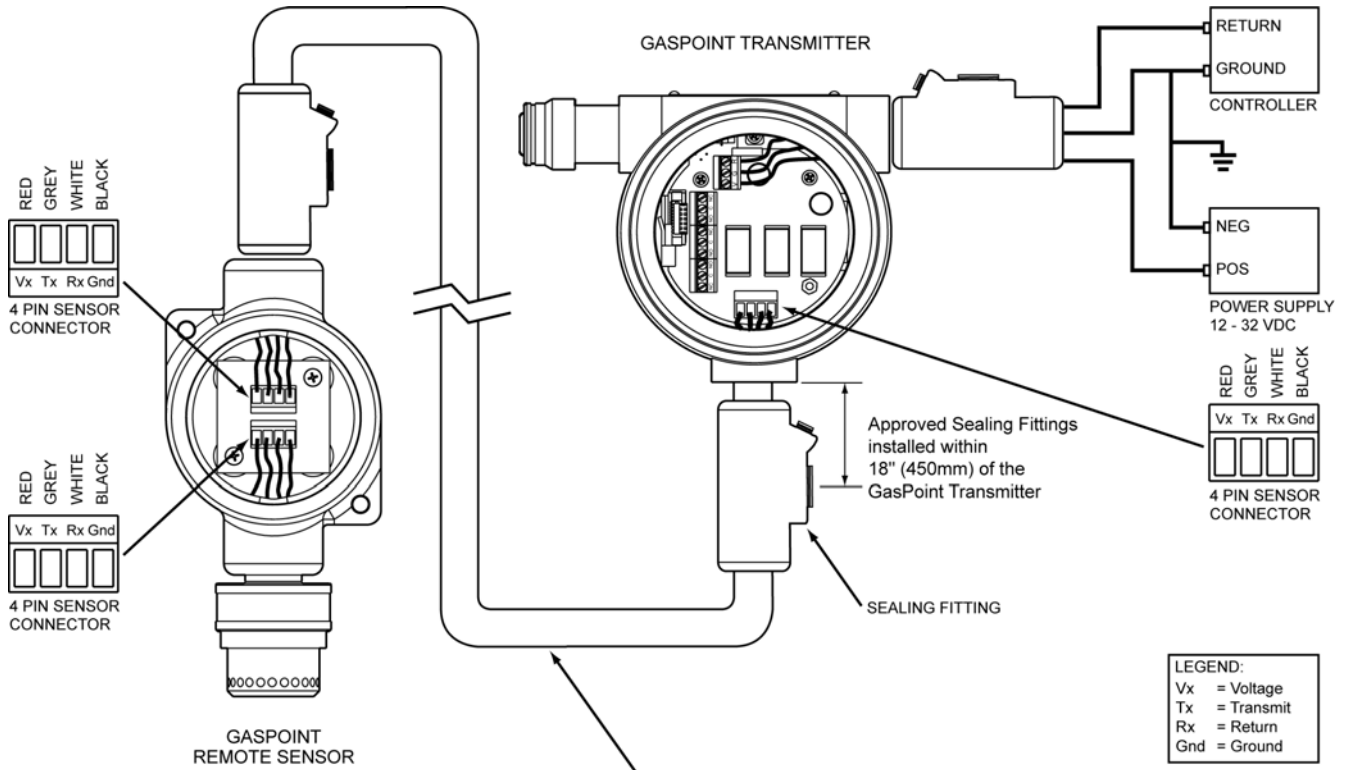

Figure 5. System Wiring Diagram

**Modbus Expansion Module Note:** For wiring of GasPoints equipped with the Modbus Communication Expansion Module, see the Modbus manual for additional wiring information.



**APPROVED NATIONAL ELECTRICAL CODE INSTALLATION**  
**CONDUIT** or **APPROVED HAZARDOUS LOCATION CABLE** connecting the Remote Sensor and Transmitter must have Sealing Fittings at both ends within 18" (450mm) of each unit.  
**HAZARDOUS LOCATION CABLE** and **SEALING FITTINGS** must be approved for Class 1, Div. 1 Gr. B,C,D Hazardous Locations.

Figure 6. Sensor separation Kit Wiring Diagram

### Mounting the Sensor Separation Kit Enclosure

1. The separation kit is equipped with predrilled flanges: I.D. 3065 (7.68 mm) on 4.35 in. (10.6 mm) centers.
2. Disconnect the wires from the transmitter terminal block and remove the sensor from the transmitter. Screw the sensor fully into the separation kit housing and install the wires, as shown on the diagram, to the adjacent terminal block in the separation kit.
3. Install cable as shown. Ensure correct cabling and sealing fitting practices are implemented.

## Factory Settings

The transmitter is calibrated and tested before shipping. Commonly used values are set at the factory. To change the factory default settings, refer to [Changing the Alarm Setpoints](#).

The following settings are field selectable:

### Dip Switch Overview

- Calibration Time Delay:** To set span, select a time delay of 30 seconds or 6 minutes. For remote calibration use the 6 minute setting to allow time for the gas to reach the sensor. To save time and calibration gas, the transmitter begins the span procedure when it senses the calibration gas.

**Note:** The factory default is 30 seconds. See dip switch 3 (CAL TIME) to change to 6 minutes.

- Measuring Range:** Select from up to four measuring ranges by setting Block 1 switch 4 and switch 5 to open or closed. Both switch 4 and 5 are factory set to open. Refer to Table 8.
- Low and/or High Relays:** Select non-latching or latching. Factory default is set to open (non-latching).
- Low and/or High Relays:** Select de-energized or energized. Factory default is set to open (de-energized).

### Changing the Alarm and Calibration Gas Setpoints

- Gas Alarms:** Gas alarm levels are set to Occupational Safety & Health Administration (OSHA) standards prior to shipping. The transmitter is equipped with two alarm levels, low and high. To set, select two, one, or no alarm levels and set selected levels to any value desired. To change the levels, refer to [Changing the Alarm Setpoints](#). The factory defaults are listed in Table 8.
- Calibration Gas Concentration Level:** To facilitate the auto span, the calibration gas concentration expected is preset. It can be changed at any time for the toxic and combustible gas sensors. Set the standard generally used in your facility. Refer to [Changing the Calibration Gas Concentration Level](#) to change the value.

The oxygen sensor span is set to 20.9% and cannot be adjusted (For O<sub>2</sub> calibrate in normal 20.9% ambient air, or if the atmosphere may be deficient or enriched, use pure air calibration gas.)

Table 8. Factory Default Settings; Select Measuring Ranges

Gas Sensed	Units of Measure	Select Measuring Range				Range LO: 4 Range HI: 5	Alarm Setpoints		Calibration Gas
		Factory Default 4. Open 5. Open	Or Select 4. Closed 5. Open	Or Select 4. Open 5. Closed	Or Select 4. Closed 5. Closed	Factory Defaults (Field Settable)		Factory Default Value Level Expected*	
		1	2	3	4	LOW	HIGH		
Hydrogen sulfide (H <sub>2</sub> S)	ppm	0 to 100	0 to 50	0 to 500	0 to 20	10 ppm	15 ppm	20 ppm	
Carbon monoxide (CO)	ppm	0 to 500	0 to 1000	0 to 100	0 to 50	35 ppm	200 ppm	200 ppm	
Combustibles 0-100% LEL (Catalytic or IR)	%LEL	0 to 100	N/A	N/A	N/A	10%	20%	50% LEL	
Oxygen (O <sub>2</sub> )	% by vol.	0 to 30.0%	N/A	N/A	N/A	19.5%	18.5%	20.9% ambient/pure air	
Sulfur dioxide (SO <sub>2</sub> )	ppm	0 to 100	0 to 50	0 to 20	0 to 10	2 ppm	5 ppm	20 ppm	
Hydrogen cyanide (HCN)	ppm	0 to 20.0	N/A	N/A	N/A	4.7 ppm	10 ppm	17 ppm	
Chlorine (Cl <sub>2</sub> )	ppm	0 to 5.0	0 to 10.0	0 to 50.0	0 to 99.9	0.5 ppm	1.0 ppm	3.0 ppm	
Chlorine dioxide (ClO <sub>2</sub> )	ppm	0 to 1.00	0 to 5.00	N/A	N/A	0.20 ppm	0.30 ppm	0.56 ppm	
Hydrogen (H <sub>2</sub> )	ppm	0 to 100	0 to 200	0 to 800	N/A	30 ppm	50 ppm	100 ppm	
Hydrogen chloride (HCl)	ppm	0 to 10.0	0 to 20.0	0 to 99.9	N/A	0.2 ppm	0.5 ppm	6.6 ppm	
Ammonia (NH <sub>3</sub> )	ppm	0 to 50	0 to 100	0 to 500	0 to 999	25 ppm	50 ppm	50 ppm	
Nitrogen dioxide (NO <sub>2</sub> )	ppm	0 to 50.0	0 to 10.0	0 to 20	0 to 99.9	2 ppm	5 ppm	10 ppm	

\* BW recommends that the calibration gas factory default values be changed if selecting higher measuring ranges than the factory default measuring range. Refer to [Changing the Alarm Setpoints](#) and [Sensor Specifications](#).

### Dip Switch Settings

The dip switches are located on the upper control board. To access the dip switch banks, remove the top of the explosion-proof enclosure, loosen the control board access screw (located just below the buttons), and open the control door which is on slip hinges. The dip switches are clearly labeled.

**⚠ Caution: The transmitter must be powered down before removing the outer cover. If it is in a classified area, either remove the transmitter or declassify the area.**

**Note:** Any latched relay will be released upon one push of the external button.

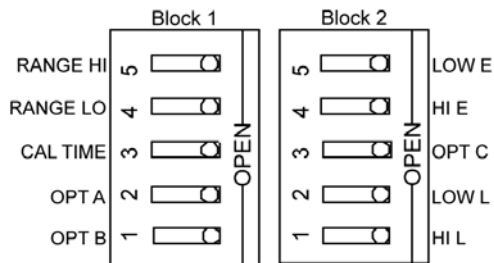

Table 9. Dip Switches

Dip Switch		Function
Block 1: Calibration and Measuring Ranges		
1	OPT B	Not used
2	OPT A	Not used
3	CAL TIME	Calibration wait period Open - 0.5 min. Closed - 6 min.
4	RANGE LO	Set measuring range
5	RANGE HI	Set measuring range
Block 2: Gas Alarm Relay Settings		
1	HI L (High alarm)	Open - Non-latching relay Closed - Latching relay
2	LOW L (Low alarm)	Open - Non-latching relay Closed - Latching relay
3	OPT C	Not used
4	HI E (High alarm)	Open - De-energized relay Closed - Energized relay
5	LOW E (Low alarm)	Open - De-energized relay Closed - Energized relay

### Connecting the Controller and Power Supply

Ensure the transmitter's external cover is in place before applying power. Follow the procedures and recommendations in the control systems manual to complete installation.

**Note:** Ensure the transmitter is tied to the controller ground, to the earth ground, and to the negative terminal of the power supply.

1. Attach wires to the controller and power supply as shown in Figure 5. When power is applied, the transmitter automatically activates.
2. The LCD shows all the display elements, and the elements flash twice. Then each icon displays separately and stays lit until all icons are displayed. The LCD backlight then activates.
3. The word **Test** displays on the LCD. The transmitter then begins a 2-minute countdown from **999** to **000**.

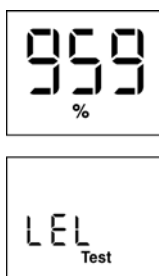

During the countdown to normal operation the transmitter communicates with the sensor, determines the sensor type, tests the sensor integrity, tests all the circuitry, and allows the sensor to stabilize before normal operation begins. The transmitter also determines the sensor range. Once initialization is complete, the transmitter enters normal operational mode (in the system loop) providing a signal to the controller of the gas present.

4. After the countdown, the LCD displays the current low alarm and high alarm setpoints. Each alarm setpoint is displayed for 4 seconds. To review them, press and release the external pushbutton after normal operation begins.

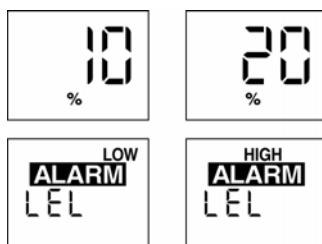

5. Upon a successful self-test, the transmitter enters normal operation and displays the ambient gas present. The backlight remains activated for 5 seconds after normal operation begins. If the unit fails the self-test, refer to [Fault Alarm Conditions and Advice](#).

### Controller Calibration

Follow the procedures and recommendations in the control system manual to calibrate the control system.

1. Calibrate the control system (see your control manuals). Set the controller as follows:
  - 4 mA = ZERO
  - 20 mA = FULL SCALE
2. Calibrate the transmitter with gas and then refer to [Changing the Alarm Setpoints and Calibration Gas Setpoints](#)



### Changing the Alarm Setpoints

The setpoint mode allows the user to change the calibration gas concentration level, the low alarm setpoint, and the high alarm setpoint. Refer to [Factory Settings](#) for factory default settings. To change the values:

1. Screw off the enclosure top. (Allows access to edit buttons.)
2. Press the OK button for 2 seconds to access setpoint mode and change factory default settings.

The transmitter is equipped with two setpoints, low and high. If only one setpoint is required, set one level to zero to deactivate. Set the other setpoint as desired.

To deactivate both alarm levels, set both setpoints to zero. If both low and high are set to the same value, the transmitter will trigger a high alarm condition if that setpoint is met or exceeded.

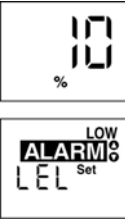
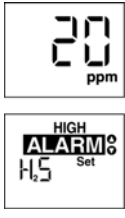
Changing setpoint	LCD icons displayed	Display
<p><b>Changing the Calibration Gas Concentration Level</b></p> <p>The LCD first displays the current calibration gas value. Press OK to accept the displayed value or proceed to change the value. The factory default value for O<sub>2</sub> is set for 20.9% and cannot be adjusted.</p> <ol style="list-style-type: none"> <li>1. Press ▲ to increment the value or ▼ to decrement the value.</li> <li>2. Press OK to accept the new displayed value and end set calibration gas level.</li> </ol>	<ul style="list-style-type: none"> <li>• Numeric display shows current calibration gas value expected</li> <li>• <b>Set Span</b> icon flashes</li> <li>•  flash</li> <li>• ▲▼ flash</li> </ul>	
<p><b>Changing the Low Alarm Setpoint</b></p> <p>The next screen displays the current low alarm setpoint. Press OK to accept the current low alarm setpoint or proceed to change the value.</p> <ol style="list-style-type: none"> <li>1. Press ▲ to increment the value or ▼ to decrement the value.</li> <li>2. Press OK to accept the new displayed value and end set low alarm setpoint.</li> </ol>	<ul style="list-style-type: none"> <li>• Numeric display shows current low alarm setpoint</li> <li>• <b>LOW ALARM set</b> icon flashes</li> <li>• ▲▼ flash</li> </ul>	
<p><b>Changing the High Alarm Setpoint</b></p> <p>The next screen displays the current high alarm setpoint. Press OK to accept the current high alarm setpoint or proceed to change the value.</p> <ol style="list-style-type: none"> <li>1. Press ▲ to increment the value or ▼ to decrement the value.</li> <li>2. Press OK to accept the new displayed value and end set high alarm setpoint.</li> </ol>	<ul style="list-style-type: none"> <li>• Numeric display shows current high alarm setpoint</li> <li>• <b>HIGH ALARM set</b> icon flashes</li> <li>• ▲▼ flash</li> </ul>	

**Note:** Oxygen low and/or high gas alarm setpoints can be set to either enrichment and/or deficiency alarms as desired. If the alarm setpoint is set below 20.9% (deficiency alarm), an alarm is triggered if the concentration present is below 20.9%. If the alarm setpoint is set above 20.9% (enrichment alarm), an alarm is triggered if the concentration present exceeds 20.9%. You can choose to set both alarms above or below 20.9%, or one alarm above and one below 20.9%

3. Test the transmitter using a gas cylinder other than the one used in the calibration steps. The gas concentration should not exceed the sensor's detection range. Confirm that the display shows the expected concentration.

## Operation

The transmitter provides continuous monitoring for the target gas. In the event of power failure, the transmitter will automatically reset itself back into the system loop after power is restored. The transmitter has non-volatile memory and will not be affected by a power disruption. All programmed information is protected with total memory retention.

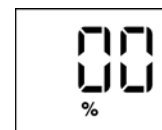

**Note:** BW recommends the transmitter be calibrated before first time use.

**LCD:** The LCD displays the current ppm or % reading of the target gas present.



**View Alarm Setpoints:** To view the alarm setpoints at any time, press the external pushbutton (for one second) and release. The LCD displays the current low alarm setpoint and then the high alarm setpoint.

### Relays:

- **Fault:** The fault relay is always energized under normal operations. The relay will de-energize only if the transmitter is addressing a fault condition or when power is released.
- **Low/High Gas Alarms:** The gas alarm relays connected are energized or de-energized (latching or non-latching) according to the transmitter dip switch settings you have selected.
- **Reset Latched Relay Alarm (Alarm Acknowledge):** If a gas alarm relay has been set to latching mode, acknowledge the alarm condition.

Press the external pushbutton for one second until the display reads low alarm setpoint, then release the external button. The transmitter releases the latched alarm(s) and displays the current low and high alarm setpoints.

**Note:** If an alarm condition exists, the transmitter will not allow the user to reset a latched alarm or display the alarm setpoints.

**Output:** The 4-20 mA loop output is normal (from 4 to 20 mA according to calibrated values) except in a fault condition.

**Backlight:** The backlight activates in low light conditions. When ambient light conditions return to normal, the backlight automatically deactivates.

### Gas Alarm Conditions and Advice

If the current gas concentration meets or exceeds either alarm setpoint, the transmitter gas alarm functions will activate.

**Note:** If both or either gas alarm is set to zero, then no gas alarm condition exists for that alarm level.

The following alarm advice activates in any gas alarm condition (low or high):

- The backlight activates.
- The 4-20 mA loop output is normal (from 4 to 20 mA according to calibrated values).

When the alarm condition no longer exists, the transmitter exits alarm mode and enters normal operation.

**Note:** If a relay is set to the latching position on either low or high gas alarm, the relay remains on until the alarm is reset (acknowledged). Press the external button to reset the relay.

If the alarms are disabled, then no alarm icons will be displayed.

An oxygen alarm level depends on which alarm setpoints have been set to low and high. The oxygen low and/or high gas alarm setpoints are user selectable for either enrichment and/or deficiency alarms as desired.

**⚠ Caution: High off-scale readings may indicate an explosive concentration.**

Table 10. Alarms

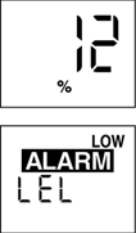
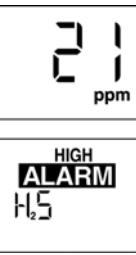
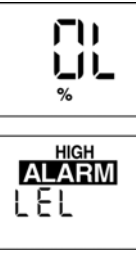
Alarm condition	Alarm relay	Alarm	Display
<p><b>LOW GAS ALARM</b></p> <p>The current gas concentration present meets or exceeds the low alarm the low alarm setpoint</p>	<p>Low alarm relay triggers field interface if the relay is connected and a low alarm setpoint is entered.</p>	<ul style="list-style-type: none"> <li>• Numeric display will show the gas currently present (ppm/%)</li> <li>• <b>LOW</b> icon displays</li> <li>• <b>ALARM</b> icon flashes</li> </ul>	
<p><b>HIGH GAS ALARM</b></p> <p>If the current gas concentration present meets or exceeds the high alarm setpoint</p>	<p>High alarm relay triggers a field interface if the relay is connected and a high alarm setpoint is entered.</p>	<ul style="list-style-type: none"> <li>• Numeric display will show the gas currently present (ppm/%)</li> <li>• <b>HIGH</b> icon displays</li> <li>• <b>ALARM</b> icon flashes</li> </ul>	
<p><b>OVER RANGE (over level or over range) GAS CONDITION</b></p> <p>If the gas concentration meets or exceeds the full measuring range</p>		<ul style="list-style-type: none"> <li>• <b>OL</b> icon displays</li> <li>• <b>HIGH</b> icon displays</li> </ul>	

**Fault Alarm Conditions and Advice**





In the event of a fault condition, the fault alarm triggers activating any connected field interface. The transmitter advises which fault condition has occurred.

Under the fault alarm conditions:

- The non-latching fault relay is activated (de-energized) during a fault condition.
- The backlight activates.

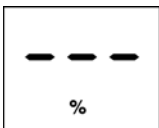
When the problem is corrected, the transmitter automatically returns to normal operation.

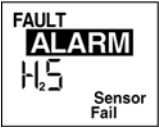
**Table 11. Fault Conditions**

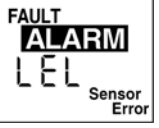
Fault Condition	4-20 mA Output	LCD Icons Displayed	Display
Sensor Self-Test Fail  (At start-up, the self-test has failed)	2.00 mA	<ul style="list-style-type: none"> <li>• Three (3) bars flash on the numeric display</li> <li>• <b>FAULT</b> icon displays</li> <li>• <b>ALARM</b> icon flashes</li> <li>• <b>Sensor Fail</b> icon displays</li> </ul>	 
Sensor Fault	2.00 mA	<ul style="list-style-type: none"> <li>• Numeric display will read the last value (ppm/%) present before sensor fault occurs</li> <li>• <b>FAULT</b> icon displays</li> <li>• <b>ALARM</b> flashes</li> <li>• <b>Sensor Fail</b> displays</li> </ul>	 
Sensor Drift	2.00 mA	<ul style="list-style-type: none"> <li>• Numeric display reads <b>00</b></li> <li>• <b>FAULT</b> icon displays</li> <li>• <b>ALARM</b> icon flashes</li> <li>• <b>Sensor Error</b> icon displays and flashes</li> </ul>	 

## Calibration

### Guidelines

When calibrating the transmitter, adhere to the following guidelines.

- Calibration accuracy is never better than the calibration gas accuracy. BW Technologies recommends a premium-grade calibration gas. Gases with National Institute of Standards and Technology (NIST) traceable accuracy improves the validity of the calibration. Do not use a gas cylinder beyond its expiration date.
- Calibrate a new sensor before use. Allow the sensor to stabilize before starting calibration (approximately 5 minutes).
- Calibrate the transmitter on a regular schedule. (BW recommends once every 90 days (3 months), depending on use and sensor exposure to poisons and contaminants.)
- Calibrate the transmitter if the ambient gas display value varies at start-up.
- It is best to calibrate the sensor before changing the alarm setpoints.
- Calibrate only in a clean atmosphere, which is free of target gas.
- Use teflon or stainless steel hose on all electrochemical sensors.
- Tygon will poison a catalytic combustible sensor over time.

### ⚠ Warning

**Opening the sensor will invalidate the calibration**

**Table 12. Calibration Diagnostics Protection**

<i>If calibration is incomplete, the transmitter automatically returns to normal operation and all prior (former) calibration data is retained. Common cause for the transmitter to refuse calibration or for an incomplete calibration include the following:</i>	
<b>Background interfering gas is present</b> If interfering gas is present during auto zero, the transmitter refuses to auto zero and exits the calibration routine.	Combustible and Toxic sensors: wait for the transmitter to return to normal operation. Then apply pure air (zero gas) and repeat calibration.
<b>Calibration gas cylinder runs empty during calibration</b>	Wait for unit to return to normal operation. Replace the empty gas cylinder with a full cylinder and repeat calibration.
<b>Calibration gas concentration is too low or too high</b> Calibration gas concentration is not within expected parameters—either the concentration of applied gas (ppm or %) is too high or too low. The transmitter refuses to set span if the calibration gas is not within the expected parameters and exits the calibration routine.	Change the value to equal the calibration gas concentration being applied.
<b>Gas applied at the wrong time</b> Gas is applied before requested to do so, or if gas is applied during auto zero, the transmitter refuses to proceed and exits the calibration routine. The prior (former) auto zero value will be retained.	Restart the calibration routine and apply gas only when the gas cylinder icon flashes.

### Remote Calibration

The length of time depends on the length of hose the calibration gas must travel. If the wait period is longer than 30 seconds, the CAL TIME dip switch must be set to 6 minutes. To save gas and time, the transmitter begins to span when it senses calibration gas.

Apply the calibration gas for approximately 2 minutes plus the time estimated for the gas to reach the sensor.

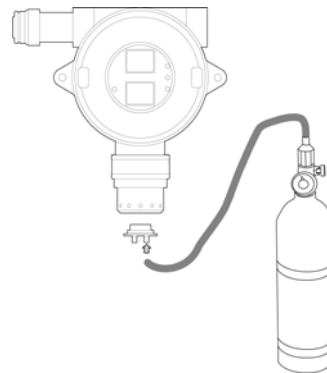
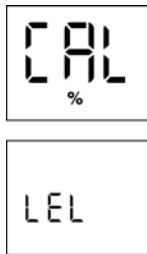
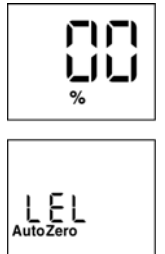
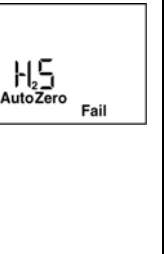
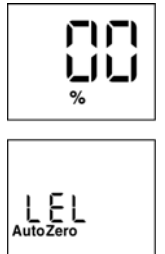
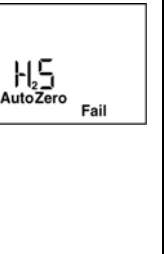
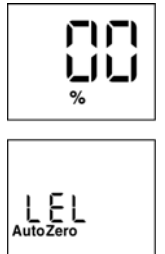
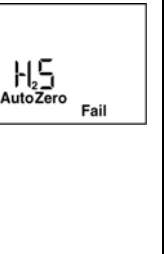

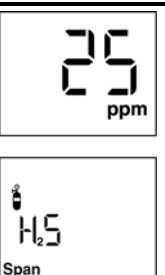

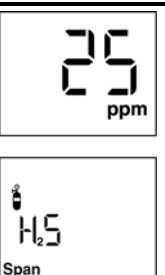

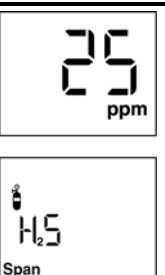



**Figure 7. Applying Gas to the Sensor**

### Calibration Procedure

The transmitter provides continuous monitoring for the target gas. In the event of power failure, the transmitter automatically resets itself back into the system loop after power is restored. The transmitter has non-volatile memory and will not be affected by a power disruption. All programmed information is protected with total memory retention.

For calibration gas concentrations and flowrates for each gas, refer to Table 16.

Calibration steps	LCD icons displayed	Display				
<p><b>START CALIBRATION</b></p> <p>1. Press and hold the external button down while the LCD displays the high and low alarm setpoints. Continue to hold the button until the LCD displays <b>CAL</b> and the CAL icon lights for 3 seconds. Then release the button.</p> <p><b>Note:</b> The 4-20 mA output will be 3mA throughout calibration. Calibrating the transmitter will not cause false alarms at the controller</p>	<ul style="list-style-type: none"> <li>First, the low and high alarm setpoints are displayed (8 seconds approximately)</li> <li>Next the <b>CAL</b> icon displays for 3 seconds</li> <li>Backlight is activated</li> </ul>					
<p><b>AUTO ZERO</b></p> <p>2. The transmitter then takes a zero level reading.</p> <ul style="list-style-type: none"> <li>Combustible and Toxic sensors: If target gas is present, apply zero gas (pure air or 100% nitrogen) to zero the sensor. Restart the calibration sequence.</li> <li>Oxygen sensor: Gas is not required. Auto zero sequence takes 30 to 60 seconds.</li> </ul>	<ul style="list-style-type: none"> <li>Numeric display reads <b>00</b></li> <li><b>Auto zero</b> icon flashes</li> </ul>	<table border="1"> <thead> <tr> <th>Auto Zero</th> <th>Auto Zero Fail</th> </tr> </thead> <tbody> <tr> <td>  </td> <td>  </td> </tr> </tbody> </table>	Auto Zero	Auto Zero Fail		
Auto Zero	Auto Zero Fail					
						
<p><b>AUTO SPAN</b></p> <p>3. Insert calibration cap. Refer to Figure 7 and apply gas to the sensor for approximately 2 minutes (5 minutes for ammonia). Refer to Table 16 for gas concentrations and flowrates.</p> <p>4. When the countdown from <b>300</b> to <b>00</b> begins, span is complete. Disconnect the gas cylinder.</p> <ul style="list-style-type: none"> <li>If Span fails: check the calibration gas cylinder used and the concentration expected. Replace the cylinder and/or change the calibration gas expected, if required. Recalibrate</li> <li>Oxygen sensor: Use pure air calibration gas (20.9 % O<sub>2</sub>) in case of deficient or enriched atmosphere.</li> </ul>	<ul style="list-style-type: none"> <li>Numeric display shows calibration gas value expected</li> <li> flashes</li> <li><b>Span</b> icon displays</li> <li>Gas type is constantly displayed</li> <li>After a successful calibration, the transmitter automatically returns to normal operation and displays the current reading (ppm or %) present.</li> </ul>	<table border="1"> <thead> <tr> <th>Auto Span</th> <th>Auto Span Error</th> </tr> </thead> <tbody> <tr> <td>  </td> <td>  </td> </tr> </tbody> </table>	Auto Span	Auto Span Error		
Auto Span	Auto Span Error					
						
<p><b>CALIBRATION FAIL OR ERROR</b></p> <p><b>Auto zero Fail:</b> If the <b>Fail</b> icon displays, the LCD displays a countdown from <b>300</b> to <b>00</b>, before the transmitter begins normal operation.</p> <p><b>Auto Span Error:</b> If the <b>Error</b> icon displays, the LCD displays a countdown from <b>300</b> to <b>00</b>, before the transmitter enters normal operation.</p> <p><b>Note:</b> If either fail condition occurs, all previous information values are retained. Retry calibration</p>	<p><b>Auto Zero:</b> If the target or an interfering gas is present, the transmitter refuses to auto zero. The <b>Fail</b> icon displays. The <b>Fail</b> icon also displays if the external pushbutton is pressed during auto zero.</p> <p><b>Span:</b> If the calibration gas is not within expected values, the transmitter refuses to span. The <b>Error</b> icon displays.</p>					

## Maintenance

To keep the transmitter in good operating condition, perform the following basic maintenance as required:

- Calibrate, test, and inspect the transmitter at regular intervals and after exposure to high concentrations.
- Keep an operations log of all maintenance, calibrations, and alarm events.
- Clean the exterior with a soft, damp cloth. Do not use solvents, soaps, or polishes.
- Do not immerse the transmitter in liquids.

## Cleaning a Sensor

The sensors are equipped with a stainless steel sintered or a hastelloy sintered flame arrestor screen (dependent on gas). Clean only with a dry brush being careful not to clog the screen. Replace the sensor if the screen is plugged.

## Clearing a Sensor

The sensor has a high degree of resistance to common vapors and gases. The sensor most likely clears itself if you remove the transmitter to a clean environment and wait 10 to 30 minutes. Do not expose a sensor to the fumes of inorganic solvents (such as paint fumes) or organic solvents.

## Troubleshooting

With enhanced diagnostics the transmitter provides extensive fault analysis and fault advice, refer to [Fault Alarm Conditions and Advice](#). The troubleshooting chart deals with other factors and is to be used as a guide. Prior to reaching any conclusion that a problem may exist, check the following:

- All terminal blocks are fully seated on the boards.
- Power and signal connections are correct and complete.

Table 13. Troubleshooting Tips

Problem	Possible Cause	Solution
No response to gas	<ul style="list-style-type: none"><li>• Sensor screen dirty</li></ul>	<ul style="list-style-type: none"><li>• Clean or replace sensor</li></ul>
Apparent false alarm	<ul style="list-style-type: none"><li>• Puff of gas</li><li>• Not properly calibrated</li><li>• Solvent fumes or interference from high levels of interfering gas</li><li>• Radio frequency interference</li></ul>	<ul style="list-style-type: none"><li>• Monitor is functioning</li><li>• Recalibrate</li><li>• Remove source</li><li>• Check grounds and shielding are correct</li></ul>
No signal at controller	<ul style="list-style-type: none"><li>• Maximum distance reached</li><li>• Controller does not operate</li></ul>	<ul style="list-style-type: none"><li>• Verify loop resistance, change wire AWG, or increase supply</li><li>• Troubleshoot controller</li></ul>

### Servicing the GasPoint

**Disassembling:** Observe all safety and electrical codes and regulations before removing front cover. Unscrew the thumbscrew and open the service bay door.

**Assembling:** When reassembling the transmitter, ensure that it is electrically complete. Close the service bay door. Ensure the thumbscrew is aligned and tighten it down. Replace the outside glass cover. Reapply power and reinitialize the transmitter's power-up procedure, refer to [Connecting the Controller and Power Supply](#). Change the alarm setpoints if desired.

**Important:** Calibrate the transmitter whenever a component is replaced.

### Sensor Assembly Replacement

To replace the entire sensor assembly, complete the following steps:

1. Power down the transmitter.
2. Disconnect the wires from the 4-pin plug-in terminal block at J5 on the power board and remove the old sensor.
3. Feed the new wires through the opening. Fully screw in the new sensor. Attach the wires to the plug-in terminal block. Ensure that all colored wires are correctly matched to the board labels from left to right. Refer to Figure 6.

**⚠ Caution: Check that all connections are correct. Incorrect wiring may damage the sensor and/or the power board.**

4. Refer to Table 8 to select a measuring range if required.

Refer to [Replacement Parts and Accessories](#) for part numbers.

**Table 14. Sensor Wiring Configuration**

	Board Label	Wire Color	Description
1	Pwr 8 Vdc	Red	Power 8 Vdc (left)
2	TX	Grey	Transmission
3	RX	White	Signal
4	GND	Black	Ground (right)

### Other Component Replacement

1. Power down the transmitter.
2. Unplug the sensor terminal block from the power board if required.
3. Replace the component, ensuring all wiring connections are complete and reassemble as shown in Figure 8. Refer to [Installation](#)
4. Ensure all field selectable options are set (measuring range, etc.).
5. Apply power and reinitialize power-up.
6. Set the alarm setpoints if required.

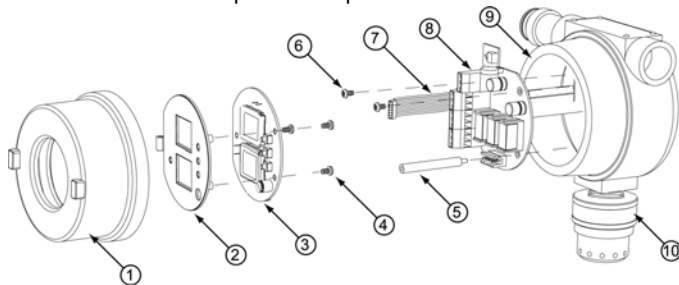

**Figure 8. Assembly Drawing**

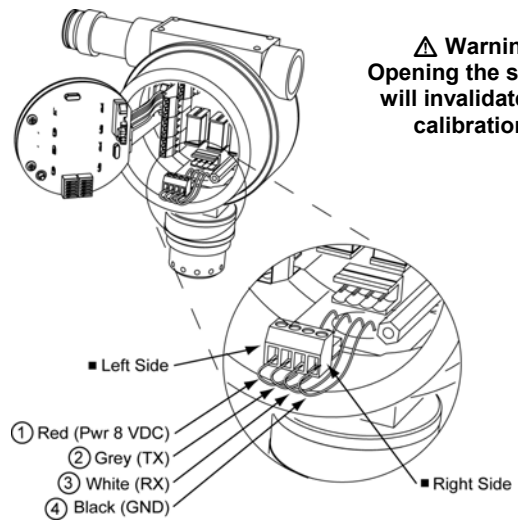

**⚠ Warning**  
Opening the sensor  
will invalidate the  
calibration.

**Figure 9. Sensor Wiring Diagram**

**Table 15. GasPoint Replacement Parts**

	Qty	Description Rating/TOL	Part #
1	1	External faceplate window cover	M1147
2	1	Internal hinged door faceplate cover	M2345
3	1	Transmitter main LCD board (PCB)	E2737/2
4	3	#6-32 x 1/4 inch machine Phillips screws	M0262
5	1	Threaded stand-off – accepts thumbscrews	M2364
6	2	#6-32 x 1/4 inch machine Phillips screws	M0262
7	1	Plug-in ribbon cable	E2800
8	1	Power/relay board (PCB)	E2739/1
9	1	Transmitter housing c/w external switch	M2346K
10	1	Sensor assembly	various

## Specifications

### Sensor Specifications

Table 16. Operating and Calibration Specifications

Specifications	IR Combustibles %LEL	Catalytic Combustibles %LEL	Hydrogen sulfide H <sub>2</sub> S ppm	Carbon monoxide CO ppm	Sulfur dioxide SO <sub>2</sub> ppm	Ammonia NH <sub>3</sub> ppm	Hydrogen cyanide HCN ppm	Nitrogen dioxide NO <sub>2</sub> ppm	Oxygen O <sub>2</sub> % v/v
Repeatability % of signal	1	1	1	1	1	<10	0.5	2	0.1
Temperature Range	°C -40 to +50 °F -40 to +122	-40 to +90 -40 to +194	-40 to +50 -40 to +122	-20 to +50 -4 to +122	-20 to +50 -4 to +122	-10 to +50 +14 to +122	-20 to +50 -4 to +122	-20 to +50 -4 to +122	-20 to +50 -4 to +122
Relative Humidity Range	0 to 100% Non Condensing								
Long Term Drift	5 to 95% Non-condensing								
Zero: % of signal loss per month Span:	Nominal <1	Nominal <1	Nominal <2	Nominal <2	Nominal <2	Nominal <2	Nominal <2	Nominal <2	Nominal <1%
LCD Increments	1%	1%	1 ppm	1 ppm	1 ppm	1 ppm	0.1 ppm	0.1 ppm	0.1%
Calibration <sup>1</sup> Flow Rate (min). mls/minute at a % or ppm reading of:	250 50% LEL	250 50% LEL	250 20 ppm	150 200 ppm	250 20 ppm	500 50 ppm	250 15 ppm	1,000 10 ppm	250 20.9 % <sup>2</sup>
Sensor: Replacement Part Numbers	IR-RW03	SS-RW02	SS-RH02	SS-RM02	SS-RS02	SS-RA02	SS-RZ02	SS-RD02	SS-RX02

1: It is recommended that the calibration gas concentration for toxic sensors be 50% of the selected measuring range. (Factory default values are shown.)

Auto span. Values expected by the transmitter for toxic gases can be changed at any time. Refer to [Changing the Alarm Setpoints and Calibration Gas Setpoints section](#).

2: For oxygen use pure air calibration gas

**Note:** Performance data is based on conditions at 20°C, 50% RH, 1013 mBar.

*Do not adjust the oxygen sensor span value.*

#### Sensors:

Toxic and Oxygen: Electrochemical  
Combustible: Catalytic or Infrared (IR)  
Position Sensitivity: None  
Operation Pressure Range: 900 to 1100 mBar (atmospheric +/-10%)

#### Calibration Notes:

For maximum accuracy, calibrate with a mixture in the range most measurements are made. For most purposes a 2 minute exposure is satisfactory. (NH<sub>3</sub>, Cl<sub>2</sub>, ClO<sub>2</sub>, and HCl need a 5 minute exposure.)

### Relative Sensitivity of Combustible Gases/Vapors

**Recommend:** For the most accurate measurements, calibrate using the gas or vapor under investigation. Where this is not possible see the applicable catalytic or infrared relative sensitivity table for combustible gases/vapors. The transmitter catalytic and combustible sensors are calibrated to methane (with 50% methane calibration gas) at the factory prior to shipping.

**Table 17. Catalytic Sensor Relative Sensitivity of Common Combustible Gases/Vapors**

Gas/Vapor	Relative Sensitivity	Gas/Vapor	Relative Sensitivity
Methane	100	Carbon monoxide	105
Propane	60	Hydrogen	100
n-Butane	60	Ammonia	125
n-Pentane	50	Cyclohexane	50
n-Hexane	40	Ethylene	85
Acetylene	80		
Each sensitivity has been rounded to the nearest 5%			

#### Catalytic Bead Combustible Sensor

The table shows the variation of the catalytic combustible sensor on exposure to a range of gases and vapors at the same %LEL concentration. The figures are expressed relative to the methane signal (=100).

The results are intended for guidance only. For a more accurate measurement calibrate using the gas or vapor under investigation.

#### Special Note on the Combustible Sensor

Certain substances have a detrimental effect on all catalytic bead sensors. The GP-WD combustible sensor has a higher degree of poison resistance and will outperform other catalytic bead sensors in poisonous atmospheres. However, catalytic sensors should not be exposed for prolonged periods of time to lead or sulfur containing compounds, silicones, or phosphates. Damage is cumulative and may result in an irreversible decrease in sensitivity. Certain other compounds, such as halogenated hydrocarbons and hydrogen sulfide, may temporarily inhibit the sensor performance, but in most cases it will recover after a period in clean air.

**Table 18. Standard Model IR GasPoint Relative Sensitivity to Applicable Combustible Gases/Vapors**

Gas/Vapor	Relative Sensitivity	Gas/Vapor	Relative Sensitivity
Acetone	60	n-Hexane	325
n-Butane	450	Methane	100
iso-Butane	450	n-Pentane	390
Butane-1	450	iso-Pentane	390
cis-Butane-2	450	Propane	410
trans-Butane-2	450	Propanol	230
Ethane	450	Propylene	310
Ethanol	330	o-Xylene	100
Ethylene	80	m-Xylene	100
n-Heptane	325	p-Xylene	100
MEK	365*	Methanol	80*
IPA	410*	Toulene	25*
Ethyl chloride	120*	Mythyl chloride	100*
*The relative sensitivity is just an estimate. This table is intended for guidance only. Always calibrate using the gas or vapor under investigation.			

#### Infrared (IR) Combustible Sensor

The standard model IR Combustible GasPoint is calibrated to methane. The table shows the variation of the IR combustible sensor on exposure to applicable group combustible hydrocarbon gases and vapors at the same %LEL concentration. The figures are expressed relative to the methane signal (=100).

The results are intended for guidance only. For a more accurate measurement, calibrate using the gas or vapor under investigation.

**⚠ Caution: IR systems should always be calibrated as soon as you install the system to compensate for any change in pressure.**

**Note:** If the hydrocarbon desired is not listed, special models are available for other groups of hydrocarbons.

*For IR sensors, use the specified gas to calibrate the system. IR sensors work very well in low or no oxygen conditions. IR sensors monitors the molar concentration of the specific gases by a physical method. No chemical reaction takes places inside the sensor.*

## Specifications

<b>Monitor:</b>	3-wire, 4-20 mA gas transmitter with advanced micro-controller based circuitry
Power Input:	12 to 32 volts dc
Output Current:	Normal Operation: Isolated linear 4-20 mA output Calibration Mode: Steady 3 mA (automatic reset to normal operation) Fault Mode: 2 mA signal (and less)
Current Consumption:	Toxic Versions: 40 mA at 24 Vdc Catalytic Combustible Version: 100 mA at 24 Vdc Infrared Combustible Version: 75 mA at 24 Vdc Relays: 50 mA per relay at 24 Vdc
<b>Sensors:</b>	Plug-in, logic sensors
Self-Test:	Automatic self-test of sensor integrity upon power on
<b>Calibration:</b>	Non-intrusive, via pushbutton Auto Zero and Auto Span
<b>Displays:</b>	Two backlit liquid crystal displays (LCD)
LCD 1:	3 digit continuous readout of the gas present (ppm or %LEL)
LCD 2:	Alphanumeric diagnostic status display
<b>Alarm Setpoints:</b>	Two (2) setpoints - User selectable
<b>Relay Contacts:</b>	Three field retro-fittable SPDT relays; 5 amps @ 250 Vac
Low/High:	Field selectable for normally energized/de-energized and latching/non-latching
Fault:	Normally energized and non-latching
<b>Controls:</b>	
Calibration:	Non-intrusive via external pushbutton
Alarm Setpoints:	Simple up/down pushbuttons with LCD readout of setpoints
<b>Physical:</b>	
Size (w x l x h):	6.8 x 7 x 4.3 in. (17 x 17.8 x 10.8 cm) including sensor
Weight:	4.85 lb. (2.2 kg) approximately
Enclosure:	Explosion-proof, anodized aluminum enclosure c/w mounting flanges
Sensor:	Stainless steel enclosure
Wiring Port:	3/4 inch n.p.t.
<b>Warranty:</b>	
Instrument:	2 years non-prorated
Sensor:	2 years warranty
<b>FCC Statement:</b>	This equipment has been tested and found to comply with the limits for a Class A digital device, pursuant to Part 15 of the FCC Rules and ICES-003 Canadian EMI requirements. These limits are designed to provide reasonable protection against harmful interference when the equipment is operated in a commercial environment. This equipment generates, uses, and can radiate radio frequency energy and, if not installed and used in accordance with the instruction manual, may cause harmful interference to radio communications. Operation of this equipment in a residential area is likely to cause harmful interference in which case the user will be required to correct the interference at his own expense.
<b>Approval:</b>	Approved by CSA to both U.S. and Canadian standards: Class I, Group B, C, D Approved by CSA to both U.S. and Canadian standards: Class II, Group E, F, G for toxic gas transmitter only Approved to Combustible Performance Standards ISA-S12.13 and C22.2 No. 152

## Replacement Parts and Accessories

Transmitters c/w Sensor Assemblies and Relays		
Model No.	Description	Qty
GP-WD	Transmitter c/w combustible sensor	1
GP-IR-WD	Transmitter c/w IR combustible sensor	1
GP-HD	Transmitter c/w hydrogen sulfide sensor	1
GP-MD	Transmitter c/w carbon monoxide sensor	1
GP-SD	Transmitter c/w sulfur dioxide sensor	1
GP-ZD	Transmitter c/w hydrogen cyanide sensor	1
GP-XD	Transmitter c/w oxygen sensor	1
GP-AD	Transmitter c/w ammonia sensor	1
GP-DD	Transmitter c/w nitrogen dioxide sensor	1
GP-CD	Transmitter c/w chlorine sensor	1
GP-VD*	Transmitter c/w chlorine dioxide sensor	1
GP-YD*	Transmitter c/w hydrogen sensor	1
GP-LD*	Transmitter c/w hydrogen chloride sensor	1

Add Suffix "-SS" for optional stainless steel transmitter enclosure  
 \*[Contact BW Technologies](#) for sensor availability.  
 Cl<sub>2</sub>, ClO<sub>2</sub> and HCl sensors are only certified for ordinary locations.  
 Sensor Assembly enclosures are stainless steel (standard)

### Accessories and Spares

Model No.	Description	Qty
D2DT	Duck mounting kit	1
GP-DUC-K1	Duct mount adapter	1
GP-1	Gas transmitter only c/w LCDs and relays (no sensor)	1
GP-SEP	Sensor separation kit	1
GP-MBUS3	MODBUS communication expansion module	1
GP-MBUS4	MODBUS communication expansion module	1
IR-RW03	IR combustible sensor assembly	1
SS-RA02	Ammonia sensor assembly	1
SS-RC02	Chlorine sensor assembly	1
SS-RD02	Nitrogen dioxide sensor assembly	1
SS-RH02	Hydrogen sulfide sensor assembly	1
SS-RL02	Hydrogen chloride sensor assembly	1
SS-RM02	Carbon monoxide sensor assembly	1
SS-RS02	Sulfur dioxide sensor assembly	1

Model No.	Description	Qty
SS-RW02	Combustible sensor assembly	1
SS-RX02	Oxygen sensor assembly	1
SS-RZ02	Hydrogen cyanide sensor assembly	1
E0036	Calibration plug	1
GP-CAL-3	Non-conductive remote calibration cup and splash guard	1
GP-SSPLASH4	Stainless Steel splash guard	1
GP-SSCAL4	Stainless steel remote calibration cup and splash guard	1
GPOINT-B	GasPoint pushbutton protective boot	1
GP-FP-MPCB1	PCB – main control board with LCDs and internal faceplate	1
GP-MPCB1	PCB - main control board with LCD	1
GP-PPCB1	PCB – power board with relays	1
GP-HART	Hart communication expansion module (2-wire system)	1
GP-2210	Internal faceplate with hinge and label	1
M1147	Enclosure with glass window	1
GP-POWER1	Power supply 110/220 Vac – 24 Vdc	1
GP-SSPB	Stainless steel process baffle	1
GP-SSPB-2	Stainless steel process baffle with NPT fitting	1
D1374	User manual	1









D1374/5 (English)

iERP: 122635

© 2006 BW Technologies, all rights reserved. Printed in Canada.  
All product names are trademarks of their respective companies.





The following information has changed in the user manual.

D1374/4 Page 26

D1374/5 Page 20

## Operating and Calibration Specifications

Specifications	Hydrogen sulfide H <sub>2</sub> S ppm	Carbon monoxide CO ppm	Sulfur dioxide SO <sub>2</sub> ppm	Ammonia NH <sub>3</sub> ppm	Hydrogen cyanide HCN ppm	Nitrogen dioxide NO <sub>2</sub> ppm	Oxygen O <sub>2</sub> % v/v
<b>Calibration<sup>1</sup>:</b>							
Flow rate (min). ml/minute	<b>250-500</b>	<b>250-500</b>	<b>250-500</b>	<b>500-1000</b>	<b>250-500</b>	<b>500-1000</b>	<b>250-500</b>
at a % or ppm reading of:	20 ppm	200 ppm	20 ppm	50 ppm	15 ppm	10 ppm	20.9% <sup>2</sup>

1: It is recommended that the calibration gas concentration for toxic sensors be 50% of the selected measuring range. (Factory default values are shown).

**Note:** Performance data is based on conditions at 20°C, 50% RH, 1013 mBar.

*Do not adjust the oxygen sensor span value.*

Auto span. Values expected by the transmitter for toxic gases can be changed at any time. Refer to Changing the Alarm Setpoints and Calibration Gas Setpoints in the user manual.

2: For oxygen use pure air calibration gas.